

# Corning® Gosselin™ Product Selection Guide

Issue 6

CORNING

Quality products  
for reliable results

# Contents

<b>Beginning-to-end Solutions for Microbiology</b> .....	<b>2</b>	<b>Sampling and Inoculation</b> .....	<b>23</b>
Corning® Gosselin™ Brand Products .....	3	Overview .....	24
Ask the Scientist .....	4	Dippers with Removable Handle .....	25
Quality Commitment .....	5	Cutlery .....	25
Product Ordering Information .....	6	Blender Bags .....	26
<b>Petri Dishes</b> .....	<b>7</b>	Clips for Bags .....	26
Overview .....	8	Straw Pipets .....	27
Contact Dishes .....	9	Transfer Pipets .....	27
Petri Dishes .....	9	Inoculating Loops .....	28
Petri Dishes for Seed Germination .....	11	Spreaders .....	30
Square Petri Dishes .....	11	<b>Transportation and Disposal</b> .....	<b>31</b>
<b>Bottles</b> .....	<b>13</b>	Overview .....	32
Overview .....	14	Autoclave Bags .....	33
Features .....	15	<b>Equipment</b> .....	<b>35</b>
Octagonal Bottles .....	16	Blender .....	36
Square Bottles .....	17	Diluter .....	36
Round Bottles .....	18	<b>Technical Appendix</b> .....	<b>37</b>
<b>Containers</b> .....	<b>19</b>	Features of Corning Gosselin Plasticware .....	38
Overview .....	20	Chemical Compatibility of Corning Gosselin Plasticware .....	39
Straight Containers .....	21	Traceability .....	40
Clear Conical Containers .....	22	Ionization Certificate .....	40
White Conical Containers .....	22	Product Label .....	40
		Glossary .....	41
		<b>Indexes</b> .....	<b>42</b>

# Beginning-to-end Solutions for Microbiology



[www.corning.com/lifesciences/solutions](http://www.corning.com/lifesciences/solutions)



For premium quality and performance in quality testing labs, you can count on Corning. In our continuous efforts to improve efficiencies and develop new tools for microbiology applications, we have scientists working in Corning labs doing what you do every day, across the globe. From sampling and preparation to bacteria growth and analysis, our technical experts understand your challenges and the changing regulatory requirements that shape your day-to-day processes.

It is this expertise, plus a 160-year legacy of Corning innovation and manufacturing excellence, that puts us in a unique position to be able to offer high quality, reliable microbiology consumables for quality testing labs. The recent introduction of our Corning® Gosselin™ line of consumables including Petri dishes, dippers and inoculating loops, has completed our portfolio, creating a beginning-to-end solution for quality testing labs across industry segments.



This product selection guide provides a step-by-step guide highlighting the Corning products and brands which support the quality testing process at each stage.

Sampling	Preparation	Testing	Analysis	Disposal

## Corning Brands for Microbiology

**Corning Gosselin** brand products are optimized for both food and beverage and environmental testing laboratories. The line of quality testing consumables complies with International Environmental standards, and includes a range of features to ensure traceability.

For 100 years, Corning has developed special glass for use in both chemical and life science laboratories. **PYREX® glassware** is made from Type 1, Class A low expansion borosilicate glass that has become the accepted standard in chemistry labs across the globe.

For more information on PYREX glassware, visit [www.corning.com/pyrex](http://www.corning.com/pyrex).

# Corning® Gosselin™ Brand Products

Corning has been a pioneering brand of disposable labware for microbiology in Europe since 1965.

Corning Gosselin products offer:

- ▶ A complete range of products to meet your testing needs
- ▶ Manufacturing facility that is:
  - CE compliant and US FDA registered for some products
  - Raw materials/resins, compliancy with 94/62/EC and REACH
  - ISO 9001 certified
  - ISO 14001 certified
- ▶ Easily accessible traceability features such as:
  - Peelable labels with lot numbers, expiration date, and sterilization information to insert in your laboratory notebook
  - Sterilization treatment visual indicator on each case
  - Certificates of Compliance can be downloaded on our website



## Scope of Applications



Food and Beverage

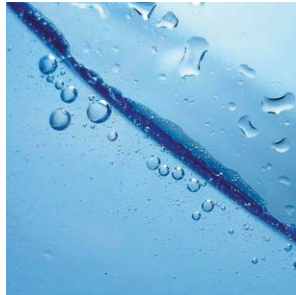

Environment



Pharmaceutical Industry



Dairy

# Scientific Support



## Ask the Scientist

Corning Scientific Support can help you succeed in any stage of your experiment. With a broad background in different life science disciplines, our support scientists offer valuable help for basic and advanced product support, designing new experiments, using the right product, and delivering the necessary product documentation.

### Scientific support at a glance:

- ▶ Pre- and post-sales application support
- ▶ Protocol setup and optimization
- ▶ Help choosing the right product
- ▶ Product documentation and information
- ▶ Product certificates
- ▶ Lot-specific information and reservation
- ▶ Troubleshooting experiments and data
- ▶ Need more? Tell us.

### We understand you

- ▶ We are scientists
- ▶ We offer extensive product experience
- ▶ We think out-of-the-box and try to find the best solution for you and your experiment

### Contact Us:

t: 800.492.1110, prompt 3

f: 978.442.2476

ScientificSupport@corning.com

Hours of Operation: Monday to Friday, 8:00 a.m. to 5:30 p.m. (Eastern Standard Time)

## Quality Commitment



### Corning® Gosselin™ SAS Quality Commitment

Corning Gosselin SAS is ISO 9001 and ISO 14001 certified. The ISO certifications verify our facilities meet international quality system standards. ISO compliance gives our customers an added level of assurance that Corning is committed to continuous improvement. To obtain copies of our ISO certificates, contact our Scientific Support Team at [ScientificSupport@corning.com](mailto:ScientificSupport@corning.com).

For more specific information on claims, visit the Certificates page at [www.corning.com/lifesciences](http://www.corning.com/lifesciences).

**Warranty/Disclaimer:** Unless otherwise specified, all products are for research use only. Not intended for use in diagnostic or therapeutic procedures. Corning Life Sciences makes no claims regarding the performance of these products for clinical or diagnostic applications

# Product Ordering Information

## Ordering Products Direct from Corning

For our U.S. customers who currently have Corning accounts, you can order direct through our Customer Service group or online:

t: 800.492.1110, prompt 2

f: 978.442.2476

CLSCustServ@corning.com

[www.corning.com/lifesciences](http://www.corning.com/lifesciences)

Hours of Operation: Monday to Friday, 8:00 a.m. to 6:00 p.m. (Eastern Standard Time)

Customers outside of the U.S., please contact your local Corning distributor, [www.corning.com/lifesciences](http://www.corning.com/lifesciences).

## Phone/Fax Orders

For each order, customers should provide the Corning product number, product description, and desired quantity. You should also include your billing and shipping address and your Corning account number.

## Online Orders

In order to purchase Corning products online, please visit the Corning Life Sciences website at [www.corning.com/lifesciences](http://www.corning.com/lifesciences). Click on “Order Now, Login” and complete the online registration form. Customers using credit cards may immediately place orders. Full Service Direct accounts with account specific contract pricing will need to establish a direct account with Corning Customer Service before online transactions can be made. You can complete the online registration form or contact Corning Customer Service directly at 1.800.492.1110 in order to establish a direct account with Corning.

## Ordering Products Through our Distribution Partners

Customers can purchase Corning products from any one of our more than 50 authorized distributors. See our complete listing of Corning distributors online at [www.corning.com/lifesciences](http://www.corning.com/lifesciences). Our distribution partners can offer our customers a variety of value added services from local inventory and service, to managed services, and preferred programs. Please contact your distributor of choice for more details.

## Pricing

Prices shown on the Corning Life Sciences website (in our online [www.corning.com/lifesciences](http://www.corning.com/lifesciences) catalog) reflect our current suggested U.S. list price. For customer specific pricing information, please contact Corning Customer Service or your authorized Corning Distributor.

## Product Return Policy

To return product, contact your local Customer Service Representative. The order and lot number details are required. Please have this information available to obtain a Return Authorization Number. This Return Authorization Number must be referenced on the outside of the shipping carton. Returns without an approved Return Authorization Number will be refused and returned at the customer's expense.



# Petri Dishes

- Overview ..... 8
- Contact Dishes..... 9
- Petri Dishes..... 9
- Petri Dishes for Seed Germination ..... 11
- Square Petri Dishes ..... 11

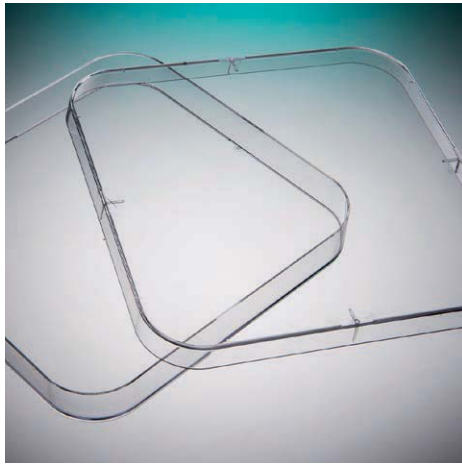
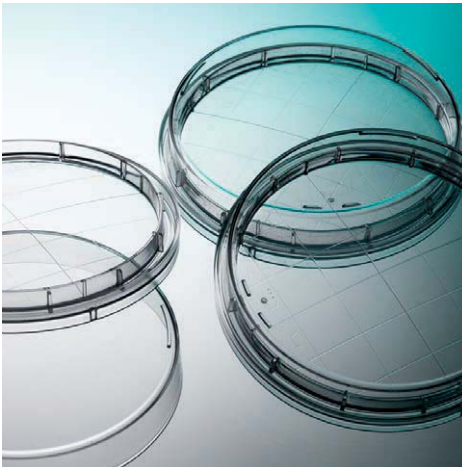



## Overview

### Advantages of Corning® Gosselin™ Petri Dishes

- ▶ **Optimal flatness:** To ensure the agar's constant depth.
- ▶ **Adequate clarity:** The injection point situated on the side of the dish bottom optimizes reading even by image analyzing systems.
- ▶ **Lightness:** Thanks to research, we have been able to determine the ideal weight of our dishes in order to reduce our customers waste disposal costs while still pursuing our objective: to provide high quality dishes.
- ▶ **Stable stacking:** The stacking ring is specially designed to improve the stacking of dishes and making them more practical to use.
- ▶ **Class 100 manufacturing environment**
- ▶ **Product traceability:** Thanks to the product label on each box, we can trace each production cycle. This label includes the lot number, the Sterilization Assurance Level (SAL), and the expiration date.
- ▶ **Raw materials:** Compliant with the European directives, especially the absence of heavy metals (94/62/EC), food compatibility (1935/2004/CE and 10/2011/CE).

### Two Types of Packaging:

#### With one outer bag:

Packaging type: Standard

Outer bag: 1

Packaging description:

- ▶ Sleeves placed directly in the case



#### Zero or double outer bags:

Packaging type: Suitable for clean room use

Outer bag: 0 or 2

Packaging description:

- ▶ Sleeves are placed in a sealed bag with bar code
- ▶ Bags placed in a second folded bag
- ▶ Final packaging in a case

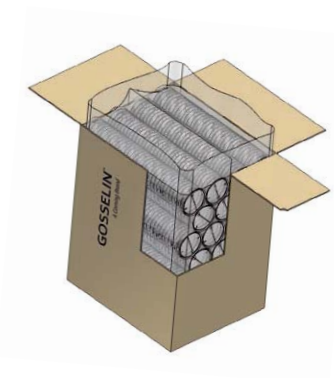



### Contact Dishes

- ▶ 0, 3, or 4 vents
- ▶ Crystal Polystyrene
- ▶ Molded grid 10 x 10 mm
- ▶ Manufactured in class 100 environment
- ▶ Easy opening

#### Easy Opening Contact Dishes, 65 mm x 14.5 mm (D x H)

Cat. No.	Vents	Description	Sterile	Units/ Sleeve	Sleeves	Outer Bag	Qty/Cs
BB60-01	0	Domed bottom, grip lid	Aseptic	20	36	2	720
BP63-10	3	Flat bottom	Yes	20	36	2	720
BB64-01	4	Domed bottom, grip lid	Yes	20	36	2	720
BB64-02	4	Domed bottom, grip lid	Aseptic	20	36	2	720



Guarantees a 19% saving in agar while maintaining the essential qualities of surface sampling.

### Petri Dishes

- ▶ 6 vents
- ▶ Crystal Polystyrene
- ▶ Optimal flatness
- ▶ Manufactured in class 100 environment
- ▶ Easy opening

#### Petri Dishes, 55 mm x 14.2 mm (D x H)

Cat. No.	Vents	Sterile	Units/Sleeve	Sleeves	Outer Bag	Qty/Cs
BP53-03	6	Yes	15	108	2	1620

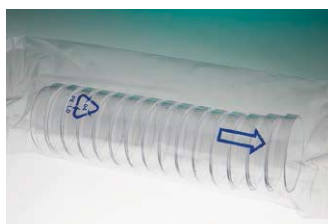

Arrows printed on recyclable sleeve to indicate the direction to open.



### Petri Dishes

- ▶ 3 vents
- ▶ Crystal Polystyrene
- ▶ Optimal flatness
- ▶ Manufactured in class 100 environment
- ▶ Easy opening

#### Petri Dishes, Clean Room Packaging, 100 mm x 15 mm (D x H)

Cat. No.	Vents	Sterile	Units/Sleeve	Sleeves	Outer Bag	Qty/Cs
BP93B-101	3	Aseptic	33	25	2	825
BP93B-102	3	Yes	33	25	2	825
BP93D-102	3	Yes	33	25	2	825



Arrows printed on recyclable sleeve to indicate the direction to open.

#### Petri Dishes, General Lab Packaging, 100 mm x 15 mm (D x H)

Cat. No.	Vents	Sterile	Units/Sleeve	Sleeves	Outer Bag	Qty/Cs
SB93-101	3	Aseptic	33	25	0	825
SB93-102	3	Yes	33	25	0	825



Slippable Petri dish

- ▶ Optically clear polystyrene (PS)
- ▶ Features four vents to provide consistent gas exchange and enhance the stability of stacked dishes
- ▶ Easy opening
- ▶ Sterility Assurance Level (SAL) of 10<sup>-6</sup>

#### Automation, Slippable, 100 mm x 15 mm (D x H)

Cat. No.	Vents	Sterile	Units/Sleeve	Sleeves	Outer Bag	Qty/Cs
BP94A-01	4	Yes	25	20	0	500



Stackable Petri dish

#### Manual, Stackable, 100 mm x 15 mm (D x H)

Cat. No.	Vents	Sterile	Units/Sleeve	Sleeves	Outer Bag	Qty/Cs
BP945-01	4	Yes	25	20	0	500

### Petri Dishes for Seed Germination



- ▶ Ideal for seed germination
- ▶ 3 vents
- ▶ Crystal Polystyrene
- ▶ Optimal flatness
- ▶ Manufactured in class 100 environment
- ▶ Easy opening

#### Petri Dishes for Seed Germination, 100 mm x 25 mm (D x H)

Cat. No.	Vents	Type	Sterile	Units/Sleeve	Sleeves	Outer Bag	Qty/Cs
BT93-02	3	Mono	Yes	10	50	0	500
BTX93-02	3	Quad	Yes	10	50	0	500

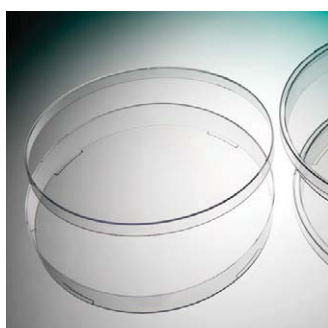

- ▶ 3 vents
- ▶ Optically clear Polystyrene (PS)
- ▶ Optimal flatness
- ▶ Manufactured in class 100 environment
- ▶ Easy opening

#### Petri Dishes, 150 mm x 15 mm (D x H)

Cat. No.	Vents	Sterile	Units/Sleeve	Sleeves	Outer Bag	Qty/Cs
BP143-06	3	Yes	11	16	2	176

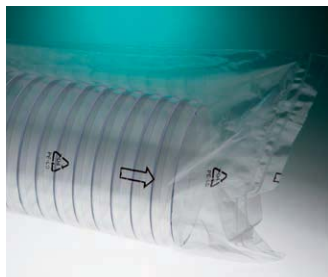

### Square Petri Dishes

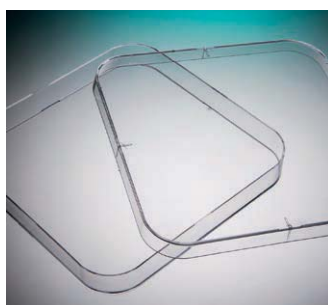

- ▶ 4 vents
- ▶ Crystal Polystyrene
- ▶ Optimal flatness
- ▶ Manufactured in class 100 environment
- ▶ Easy opening

#### Square Petri Dishes, 120 mm x 120 mm (D x H)

Cat. No.	Vents	Sterile	Units/Sleeve	Sleeves	Outer Bag	Qty/Cs
BP124-05	4	Yes	14	18	2	252





## Bottles

- Overview** ..... 14
- Features** ..... 15
- Octagonal Bottles** ..... 16
- Square Bottles** ..... 17
- Round Bottles** ..... 18

## Overview

### Advantages of Corning® Gosselin™ Bottles

- ▶ **Manufacturing process** – All bottles are produced with advanced equipment using extrusion blow molding or injection blow molding technology. Each production lot is subject to inspection throughout the entire production process according to the normative references, which are reinforced by Corning's own specifications.
- ▶ **Bottle shapes** – Corning offers a wide range of bottles: octagonal, round, square, and rectangular. Bottles are available from 30 to 2700 mL, with narrow or wide necks, and may have molded graduations.
- ▶ **Closure systems** – Various closure systems are available, from simple screw caps to tamper-evident hinged caps. All closures are designed with vertical ribs to improve handling.
- ▶ **Packaging** – Our packaging is designed to suit your needs, with individually bagged or pre-assembled bottles wrapped in packs or trays. All bottles are protected by a Polyethylene outer bag within the box to reduce the risk of particle contamination.
- ▶ **Product traceability** – Product labels on each box allow us to trace each production cycle. This label includes lot number and expiry date for sterilized products.
- ▶ **Raw materials** – Compliant with the European directives, including the absence of heavy metals (94/62/EC) and food compatibility (1935/2004/EC and 10/2011/EC).

# Features

## Cap Styles

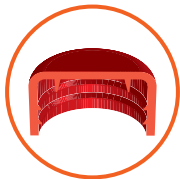

Screw cap with inner lip

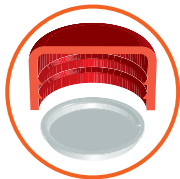

Screw cap with separate seal

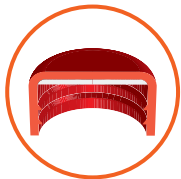

Screw cap with wad



Tamper-evident screw cap with inner lip

## PET Bottles, Tray Filmed Packaging

### Outer bag

Cat. No. P125B-06  
125 mL

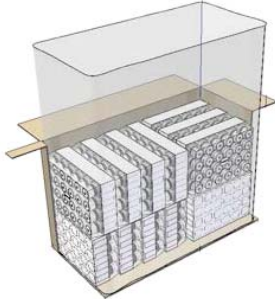

24 pieces/pack

Cat. No. P250B-06  
250 mL



24 pieces/pack

Cat. No. P500B-12  
500 mL

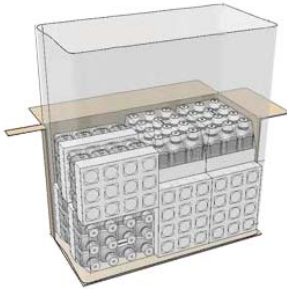

12 pieces/pack

Cat. No. P1000B-11  
1000 mL

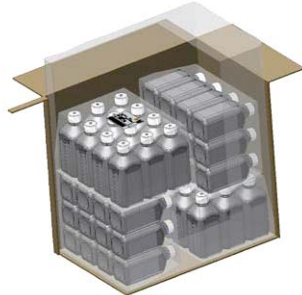

12 pieces/pack

## PET Bottles, Filmed Packaging

### Outer bag

(clean room facilities)

Cat. No. P125B-50  
125 mL

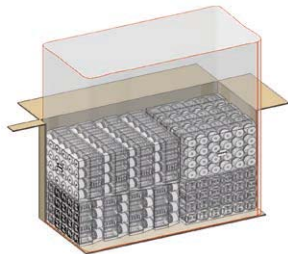

24 pieces/pack

Cat. No. P250B-50  
250 mL

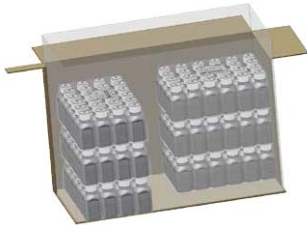

24 pieces/pack

Cat. No. P500B-50  
500 mL

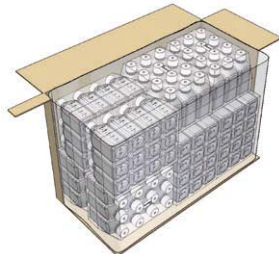

12 pieces/pack

Cat. No. P1000B-50  
1000 mL

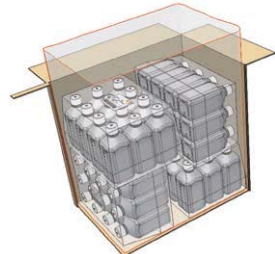

12 pieces/pack

Bottles





Example of use: microbiological media packaging.

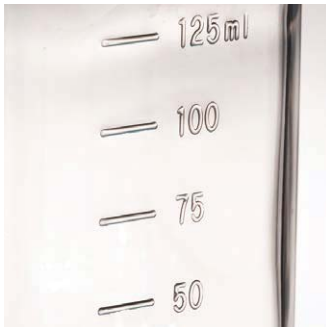





Molded graduations

### PET Octagonal Bottles





- ▶ Polyethylene terephthalate (PET) bottles
- ▶ Break resistant
- ▶ Molded graduations
- ▶ Ergonomic shape for easy handling
- ▶ Leak-proof, tamper-evident HDPE screw cap with inner lip
- ▶ Transparent as glass
- ▶ Sterility Assurance Level (SAL) of 10<sup>-3</sup>

### PET Octagonal Bottles

#### Filmed Pack with Assembled Cap

Cat. No.	Volume (mL)	A (mm)	B (mm)	C (mm)	Cap Color	Sterile	Qty/Cs
P125B-50	125	107	53	32		Yes	336
P250B-50	250	135	64	32		Yes	144
P500B-50	500	172	75	32		Yes	120
P1000B-50	1000	214	97	32		Yes	48

#### Tray Filmed Pack with Pre-assembled Cap

Cat. No.	Volume (mL)	A (mm)	B (mm)	C (mm)	Cap Color	Sterile	Qty/Cs
P125B-06	125	107	53	32		Yes	336
P250B-06	250	135	64	32		Yes	144
P500B-12	500	172	75	32		Yes	120
P1000B-11	1000	214	97	32		Yes	48



Tamper-evident screw cap with inner lip

### Bottle Dimension Key

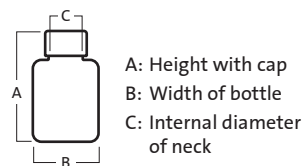

### HDPE Square Storage Bottles with Wide Neck



- ▶ HDPE resin is lightweight and break-resistant
- ▶ Screw cap with wad
- ▶ For storage of liquid, semi liquid, and solid forms
- ▶ Large neck opening provides easier access for liquid transfer
- ▶ Graduated bottles (except 150 mL)
- ▶ Bulk packed in one folded outer bag
- ▶ Food contact compliant
- ▶ Sterility Assurance Level (SAL) of 10<sup>-3</sup>



### HDPE Square Storage Bottles with Wide Neck

Cat. No.	Volume (mL)	A (mm)	B (mm)	C (mm)	Cap Color	Sterile	Qty/Cs
LC150A-05	150	95	50	37		Yes	300
LC150A-23	150	95	50	37		No	245
LC250-06	250	109	57	37		Yes	210
LC500-11	500	122	76	58		Yes	175
LC1000-13	1000	185	76	58		Yes	90
LC2000-03*	2000	230	96	58		Yes	50
LC2500A-07	2500	268	109	77		Yes	35

\*Screw cap with separate seal.

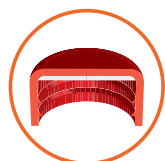

Screw cap with wad

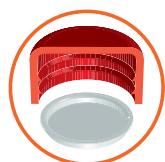

\*Screw cap with separate seal

### Bottle Dimension Key

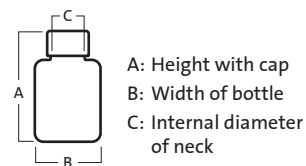







### HDPE Round Storage Bottles with Wide Neck

- ▶ HDPE resin is lightweight and break-resistant
- ▶ Screw cap with wad
- ▶ For storage of liquid, semi liquid, and solid forms
- ▶ Large neck opening provides easier access for liquid transfer
- ▶ Food contact compliant
- ▶ Bulk packed in one folded outer bag
- ▶ Sterility Assurance Level (SAL) of  $10^{-3}$



### HDPE Round Storage Bottles with Wide Neck

Cat. No.	Volume (mL)	A (mm)	B (mm)	C (mm)	Cap Color	Sterile	Qty/Cs
LR50A-18	50	77	36	27		Yes	600
LR100-12	100	80	51	37		Yes	335
LR150A-14	150	108	51	37		Yes	250
LR250-09	250	125	60	37		Yes	145
LR500-04	500	136	80	58		Yes	140
LR1000-08	1000	174	101	58		Yes	68

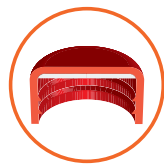

Screw cap with wad

### Bottle Dimension Key

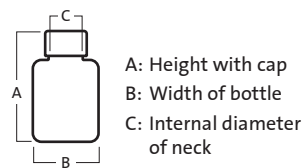



## Containers

Overview .....	20
Straight Containers .....	21
Clear Conical Containers .....	22
White Conical Containers .....	22

## Overview

### Advantages of Corning® Gosselin™ Containers

- ▶ **Manufacturing process:** All containers are produced with high-tech equipments using molding technology. Most of our products are assembled in line to avoid any external contaminations. The raw plastics used are virgin and comply with the environmental standards in force. Each production lot is subject to inspection throughout the entire production process according to the standard referenced, which are reinforced by Gosselin's own specifications.
- ▶ **Container shape:** A wide range of straight containers, conical containers, and pots to meet customers' requirements. Containers are available from 25 mL to 1000 mL.
- ▶ **Closure systems:** Closure systems for our containers are suitable for normal use. Closure systems are available with hinged caps, screw caps, or snap caps.
- ▶ **Packaging:** Perfectly adapted to the user's needs: single bag, packing of containers into boxes, screw-capped containers wrapped on trays. All containers are protected by a polyethylene outer bag placed inside the boxes beforehand to avoid particle contamination.
- ▶ **Product traceability:** Thanks to the product label on each box, we can retrace each production cycle. This label includes lot number and expiry date if the product has been sterilized.
- ▶ **Raw materials:** Compliant with European directives, including the absence of heavy metals (94/62/EC) and food compatibility (1935/2004/EC and 10/2011/EC), and CE marking relating to medical devices for *in vitro* diagnostics (98/79/EC).



**Products compliant with international standards**

**Wide scope of applications**

**Range of products suitable worldwide**

**Packaging suitable for users' needs**

## Straight Containers



- ▶ Auto-stable hinged cap
- ▶ Containers and caps made of Polypropylene (PP)
- ▶ Optimized volume for milk sampling
- ▶ Shock resistant
- ▶ With or without writing area
- ▶ Bulk packed in one folded outer bag

### PP Transparent Straight Containers, Hinged Cap

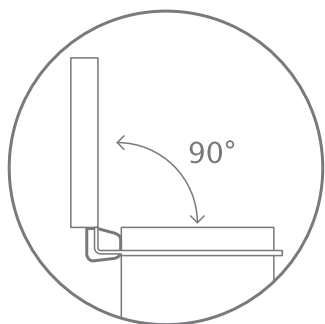

Auto-stable cap

Cat. No.	Volume (mL)	Height (mm)	Diam. (mm)	Cap Type	Writing Area	Sterile	Qty/Cs
FL52-02	45	85	29		Yes	Yes	650
FL60-04*	50	78	31		Yes	Yes	650
FL100-05*	90	80	43		Yes	Yes	350
FL300-04*	300	88	75		No	Yes	240

\*FL60 graduated every 10 mL, FL100 graduated at 80 mL, FL300 graduated every 25 mL.

## Straight Containers



- ▶ Clear Polypropylene (PP) containers
- ▶ Polyethylene (PE) leakproof screw-cap with inner lip
- ▶ Red cap, natural body

### PP Clear Straight Containers

Cat. No.	Volume (mL)	Height (mm)	Diam. (mm)	Cap Type	Sterile	Pcs/Bag	Qty/Cs
TP35C-002	60	70	33		Yes	70	700
TP35C-013	60	70	33		No	70	700
TP52C-002	125	74	52		Yes	380	380
TP53C-002	180	102	52		Yes	264	264

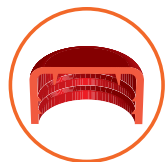





Screw cap  
with inner lip



### Clear Conical Containers

- ▶ Clear Polypropylene (PP) containers
- ▶ Polyethylene snap-cap
- ▶ Molded graduations
- ▶ Bulk packed in one folded outer bag

#### PP Clear Conical Containers



Cat. No.	Volume (mL)	Height (mm)	Diam. (mm)	Cap Type	Sterile	Qty/Cs
PC200A-02	200	88	62		Yes	220
PC400-09	400	100	85		No	185
PC400-03	400	100	85		Yes	185
PC1000-05	1000	130	105		Yes	80

### White Conical Containers

- ▶ White Polypropylene (PP) containers
- ▶ Clear polyethylene leakproof snap cap
- ▶ Molded internal graduations
- ▶ Bulk packed in one folded outer bag



#### White PP Conical Containers

Cat. No.	Volume (mL)	Height (mm)	Diam. (mm)	Cap Type	Sterile	Qty/Cs
PC200A-07	200	88	62		Yes	220
PC400-05	400	100	85		Yes	185
PC1000-04	1000	130	105		Yes	80





## Sampling and Inoculation

Overview .....	24
Dippers .....	25
Cutlery .....	25
Blender Bags .....	26
Clips for Bags .....	26
Straw Pipets .....	27
Transfer Pipets .....	27
Inoculating Loops .....	28
Spreaders .....	30



## Overview

### Advantages of Sampling and Inoculation Products

- ▶ **Use:** A full range of disposable products from sampling to inoculation. Packaging has been designed to meet the user's expectations (individual wrapping, multiple packs). Our products are adapted in terms of packaging and product specification.
- ▶ **Packaging:** All Corning® Gosselin™ products are protected by a polyethylene outer bag placed inside the boxes beforehand to prevent any risk of particle contamination.
- ▶ **Product traceability:** Thanks to the product label on each box, we can retrace each production cycle. This label includes lot number and expiry date if the product has been sterilized.
- ▶ **Raw materials:** Compliant with the European directives in force, especially the absence of heavy metals (CE N°1935/2004) and food compatibility (94/62/EC).

### From Sampling to Inoculation

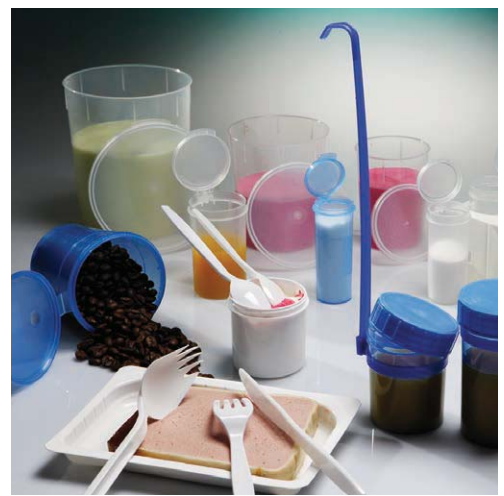

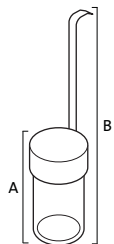

### Dippers with Removable Handle

- ▶ Blue Polypropylene (PP) containers
- ▶ Removable handle
- ▶ Single resealable bag
- ▶ Tamper-evident
- ▶ Sampling/Transportation

### PP Dippers with Removable Handle

Cat. No.	Volume (mL)	A (mm)	B (mm)	Diam. (mm)	Sterile	Pcs/Bag	Qty/Cs
TAT30C-01*	40	70	275	30	Yes	1	250
T AFL1-01**	90	80	290	43	Yes	1	150
TAT52C-01*	125	74	275	52	Yes	1	100
TAT53C-01*	180	102	305	52	Yes	1	100

\*Screw cap.  
\*\*Hinged cap.

### Cutlery

- ▶ Strong Polystyrene (PS) cutlery
- ▶ Complete range
- ▶ Sampling

### PS Cutlery

Cat. No.	Description	Volume (mL)	Length (mm)	Sterile	Pcs/Bag	Qty/Cs
COU-02	Knife	–	175	Yes	1	1000
FOUR-01	Fork	–	155	Yes	1	1000
CUIP-01	Small spoon	2	125	Yes	1	1000
CUIG-01	Large spoon	8	150	Yes	1	1000
CFM-01	Multifunction cutlery	–	180	Yes	1	500



Multifunction cutlery

### Blender Bags

- ▶ Polyethylene bags
- ▶ Samples blending
- ▶ Highly resistant
- ▶ Traceability on each filter bag



#### Blender Bags without Filter

Cat. No.	Volume (mL)	HxL (mm)	Thickness (µm)	Sterile	Packaging	Qty/Box	Qty/Cs
SM1-01	80	150 x 105	70	Yes	25	60 x 3	4500
SM2-01	400	300 x 180	70	Yes	50	10 x 5	2500
SM3-01	3500	510 x 380	70	Yes	25	5 x 4	500

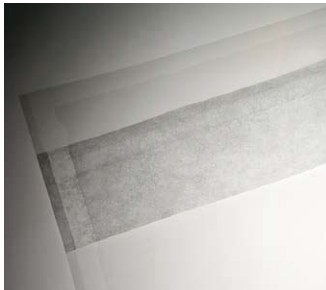

#### Blender Bags with Filter

Cat. No.	Volume (mL)	HxL (mm)	Thickness (µm)	Sterile	Packaging	Qty/Box	Qty/Cs
BBAG-03*	400	300 x 190	62	Yes	25	20 x 3	1500
BBAG-04*	400	300 x 190	62	Yes	50	10 x 3	1500
FBAG-03**	400	300 x 190	62	Yes	25	20 x 3	1500
FBAG-04**	400	300 x 190	62	Yes	50	10 x 3	1500

\*Side filter

\*\*Full filter



Traceability on each filter bag

### Clip for Bags

Cat. No.	Color	Sterile	Pcs/Bag	Qty/Box	Qty/Cs
CLIP-01	Blue/White	No	50	200	1000



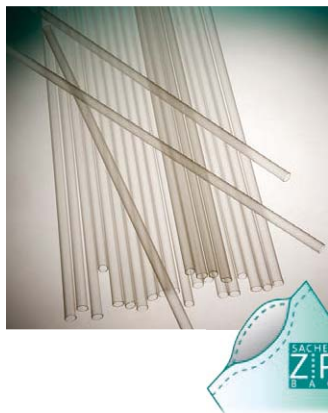

### Straw Pipets

- ▶ Polypropylene (PP) straw pipets
- ▶ Packed in tamper-evident resealable plastic bag
- ▶ Liquid sampling
- ▶ Universal size

#### PP Straw Pipets

Cat. No.	Volume (mL)	Length (mm)	Sterile	Pcs/Bag	Qty/Box	Qty/Cs
EPI1B-01	1	190	Yes	25	1000	12000
EPI1B-05	1	150	Yes	100	1000	12000
EPI24B-01	2.2	240	Yes	25	240	6000
EPI24B-02	2.2	240	Yes	50	120	6000
EPI5-01	5	187	Yes	10	300	3600

### Transfer Pipets

- ▶ Polyethylene (PE) graduated pipets
- ▶ Supple
- ▶ Complete and quick removal of liquid

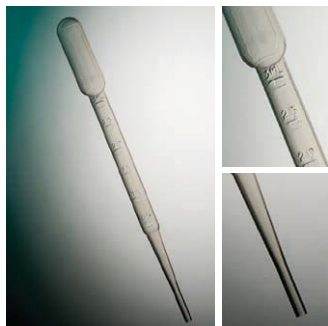

#### PE Transfer Pipets

Cat. No.	Volume (mL)	Length (mm)	Sterile	Packaging	Qty/Box	Qty/Cs
PAS1A-01*	1	150	Yes	1	200	2000
PAS3A-01*	3	150	Yes	1	200	2000

\*Peelable bag.

### Inoculating Loops

- ▶ Highly ergonomic
- ▶ Flexible Polystyrene (PS)
- ▶ Gentle on agar
- ▶ Spherical extremity (1 µL and 10 µL)
- ▶ Packed in tamper-evident resealable bags

#### PS Inoculating Loops – Spherical Extremity

Cat. No.	Volume (µL)	Length (mm)	Color	Sterile	Pcs/Bag	Pcs/Box	Qty/Cs
OS1B-01	1	195	Green	Yes	20	150 x 3	9000
OS10B-02	10	195	Blue	Yes	20	150 x 3	9000



Spherical Extremity – 1 µL



Spherical Extremity – 10 µL

### Inoculating Loops

- ▶ Highly ergonomic
- ▶ Flexible Polystyrene (PS)
- ▶ Gentle on agar
- ▶ Needle extremity (1 µL and 10 µL)
- ▶ Packed in tamper-evident resealable plastic bags

#### PS Inoculating Loops – Needle Extremity

Cat. No.	Volume (µL)	Length (mm)	Color	Sterile	Pcs/Bag	Pcs/Box	Qty/Cs
OS1-01	1	192	Crystal green	Yes	20	150 x 3	9000
OS10-02	10	194	Crystal blue	Yes	20	150 x 3	9000



Needle Extremity – 1 µL



Needle Extremity – 10 µL

### Spreaders

- ▶ Polystyrene (PS) spreaders
- ▶ Packed in tamper-evident resealable bags



#### Spreaders, L-shape, Curved End

Cat. No.	Length (mm)	Color	Sterile	Pcs/Bag	Pcs/Box	Qty/Cs
ETAR-01	148	White	Yes	25	1000	5000
ETAR-05	148	White	Yes	50	1200	6000

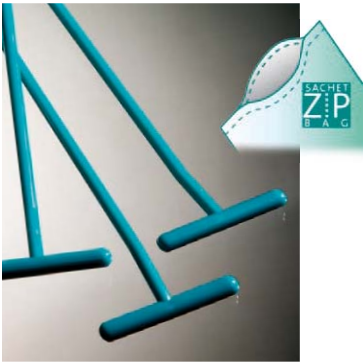

#### Spreaders, T-shape, More Precise

Cat. No.	Length (mm)	Color	Sterile	Pcs/Bag	Pcs/Box	Qty/Cs
ETAT-04	150	Green	Yes	25	700	3500

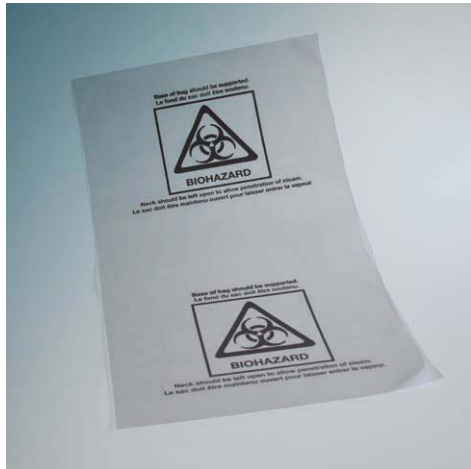

## Transportation and Disposal

<b>Overview</b> .....	32
<b>Autoclavable Bags</b> .....	33
Transparent Autoclavable Bags .....	33
Biohazard Printed Logo Autoclavable Bags .....	33



## Overview

### Advantages of Transportation and Disposal Range of Products

- ▶ **Use:** These products meet the usual requirements for the different applications (clinical, microbiology, industrial). Our transportation products comply with industry standards where applicable.
- ▶ **Packaging:** All products are protected by a polyethylene outer bag placed inside the box beforehand to avoid any risk of particle contamination.
- ▶ **Product traceability:** Thanks to the product label on each box, we can trace each production cycle. This label includes lot number and expiry date if the product has been sterilized.
- ▶ **Raw materials:** Compliant with the European directives in force, especially the absence of heavy metals (CE N°1935/2004) and food compatibility (94/62/EC).

### Transportation and Disposal



### Autoclave Bags

- ▶ Polypropylene resistant bags
- ▶ Every bag is 40 µm thick
- ▶ Wide range of volumes (3000 mL to 33000 mL)
- ▶ Nonsterile



#### Transparent Autoclave Bags

Cat. No.	Volume (mL)	Height (mm)	Length (mm)	Thermal Resistance	Qty/Cs
SA03-01	3000	400	255	134°C - 273°C	500
SA09-01	9000	500	300	134°C - 273°C	500
SA14-01	14000	600	400	134°C - 273°C	500
SA21-01	21000	780	400	134°C - 273°C	500
SA33-01	33000	780	600	134°C - 273°C	500



#### Biohazard Logo Printed Autoclave Bags

Cat. No.	Volume (mL)	Height (mm)	Length (mm)	Thermal Resistance	Qty/Cs
SA03-10	3000	400	255	134°C - 273°C	500
SA09-10	9000	500	300	134°C - 273°C	500
SA14-10	14000	600	400	134°C - 273°C	500
SA21-10	21000	780	400	134°C - 273°C	500
SA33-10	33000	780	600	134°C - 273°C	500



Biohazard sign on printed bags

#### Recommendation:

Bags must not be tightly sealed to withstand the temperature recommended for 20 minutes in autoclave.





## Equipment

Corning® Gosselin™ Blender .....	36
Corning Gosselin Diluter .....	36



## Corning® Gosselin™ Blender



### Easy to Clean

- ▶ Removable stainless steel paddles
- ▶ Autoclavable paddles and door
- ▶ Removable blending chamber
- ▶ Built-in waste drawer

### Adjustable Speed, Time, and Blending Strength

- ▶ Blending capacity: 80 to 400 mL bags
- ▶ Program setting mode (9 programs)
- ▶ Adjustable timer: 10 seconds to 210 seconds, or continuous
- ▶ Adjustable speed (strokes/min.): slow (450), normal (550), and fast (650)

### Other Features

- ▶ Low noise level (51 dBA)



### Corning Gosselin Blender

Cat. No.	Description	Qty/Cs
S-Blender-1A	Blender, 110V	1

## Corning Gosselin Diluter

### Easy to Use

- ▶ Includes a removable bag holder
- ▶ Intuitive software with pictograms
- ▶ Dual pump mode to reduce dilution time
- ▶ Recordable dilution parameters

### Accurate

- ▶ Weighing accuracy  $\leq 1\%$  for weights greater than 5 g
- ▶ Dilution accuracy  $< 1\%$



### Corning Gosselin Diluter

Cat. No.	Description	Qty/Cs
S-Diluter-1	Diluter	1



## Technical Appendix

Features of Corning® Gosselin™ Plasticware .....	38
Chemical Compatibility of Corning Gosselin Plasticware .....	39
Traceability .....	40
Ionization Certificate.....	40
Product Label .....	40
Glossary.....	41

## Features of Corning® Gosselin™ Plasticware

Reagents	HDPE		PS		PP		LDPE		PET	
	68°F 20°C	122°F 50°C	68°F 20°C	122°F 50°C	68°F 20°C	122°F 50°C	68°F 20°C	122°F 50°C	68°F 20°C	122°F 50°C
Perchloric acid	G	N	G	F	G	N	G	N	F	F
Phosphoric acid 85%	R	R	R	G	R	G	R	R	F	F
Sulphuric acid 20%	R	R	R	G	R	G	R	R	N	N
Trichloroacetic acid	G	F	F	N	R	G	G	F	F	N/A
Butyl alcohol	R	R	G	G	R	R	R	R	G	G
Ethyl alcohol	R	R	F	N	R	G	R	G	G	G
Methyl alcohol	R	R	F	N	R	R	R	R	G	F
Acetaldehyde	G	F	N	N	G	N	G	N	F	N
Aniline	R	G	F	F	G	F	R	G	G	F
Benzene	G	G	N	N	G	F	G	N	F	N
Potassium dichromate	R	R	R	G	R	G	R	G	F	N/A
Bromine	F	N	N	N	N	N	N	N	N	N
Bromoform	N	N	N	N	N	N	N	N	N	N
Butadiene	F	N	N	N	N	N	N	N	N	N
Cellosolve	R	R	F	F	R	G	R	G	N/A	N/A
Chlorine (moist)	G	F	N	N	G	N	G	N	N	N
Chlorine in air	R	F	F	N	G	N	G	N	N	N
Chloroform	G	F	N	N	G	F	F	N	N	N
Amyle chloride	F	N	N	N	N	N	N	N	N	N
Ethylene chloride	G	F	N	N	F	N	G	N	N	N
Ethyl chloride	F	F	N	N	F	N	F	N	N	N
Methylene chloride	G	F	N	N	F	N	F	N	N	N
Thionil chloride	N	N	N	N	N	N	N	N	N	N
Cresol	F	N	N	N	G	F	N	N	N	N
Cyclohexane	R	G	N	N	G	F	G	F	R	N/A
P-dichlorobenzene	G	F	N	N	G	F	F	N	F	F
Dioxane	G	G	N	N	G	F	G	F	R	R
Hydrogen peroxide	R	R	R	G	R	G	R	G	R	R
Gasoline	G	G	N	N	G	F	F	N	R	G
Petroleum ether	F	N	F	F	G	F	F	F	R	G
Ethyl ether	N	N	N	N	N	N	F	N	R	G
Formaldehyde	R	R	G	G	R	G	R	G	R	R
Hexane	R	R	N	N	R	R	R	R	R	R
Mineral oil	R	R	R	R	R	R	G	N	R	R
Calcium hypochlorite	R	R	G	F	R	R	R	R	R	R
Sodium hypochlorite	R	R	R	R	R	R	R	R	G	N/A
Kerosene	G	G	N	N	G	F	F	N	R	R
Methyl isobutyl ketone	R	G	N	N	G	F	G	F	G	F
Silver nitrate	R	G	G	F	R	G	G	F	R	R
Ethylene oxide	F	F	N	N	F	F	G	F	N/A	N/A
Potassium permanganate	R	R	G	G	R	G	R	G	R	R
Phenol	G	F	N	N	G	N	G	N	N	N
Propane	F	N	N	N	N	N	N	N	F	N
Turpentine	G	G	N	N	G	F	F	N	G	G
Carbon tetrachloride	G	F	N	N	G	F	F	N	R	R
Tetrahydrofuran	G	F	N	N	G	F	F	N	N	N
Trichloroethane	F	N	N	N	N	N	N	N	N	N
Trichloroethylene	F	N	R	R	N	N	N	N	F	N
Toluene	G	G	N	N	G	F	F	N	R	N
Urea	R	R	G	G	R	R	R	R	R	R
Xylene	G	F	N	N	F	N	G	N	N	N

G = Good resistance for continuous use not exceeding 30 days  
 F = Fair resistance for continuous use not exceeding 7 days  
 N = Not recommended for continual use  
 R = Excellent resistance  
 N/A = Not applicable

HDPE = High-density polyethylene  
 LDPE = Low-density polyethylene  
 PET = Polyethylene terephthalate  
 PP = Polypropylene  
 PS = Polystyrene

## Chemical Compatibility of Corning® Gosselin™ Plasticware

Reagents (20°C)	HDPE	PS	PP	LDPE	PET
Weak or diluted acids	R	R	R	R	R
Strong or concentrated acids	R	F	R	R	N
Aliphatic alcohols	R	R	R	R	F
Aldehydes	G	N	G	G	G
Bases	R	R	R	R	N
Esters	G	N	G	G	G
Aliphatic hydrocarbons	G	N	G	F	G
Aromatic hydrocarbons	G	N	F	F	N
Halogenated hydrocarbons	F	N	F	N	N
Cetane	G	N	G	G	F
Oxidizing agents	F	N	F	F	F

**G** = Good resistance for continuous use not exceeding 30 days  
**F** = Fair resistance for continuous use not exceeding 7 days  
**N** = Not recommended for continual use  
**R** = Excellent resistance  
**N/A** = Not applicable

HDPE = High-density polyethylene  
 LDPE = Low-density polyethylene  
 PET = Polyethylene terephthalate  
 PP = Polypropylene  
 PS = Polystyrene

The data in this catalog are based on information and documentation provided by our raw material suppliers and on our own many years of technical experience. Customers should test our products to ensure that they are suitable for their own specific requirements. The information provided is for guidance only and we cannot accept further responsibility.



## Traceability

All Corning® Gosselin™ products come with convenient traceability features such as labels with lot number and expiration date. These labels easily peel-off and can be placed in your laboratory notebook.

### Ionization Certificate

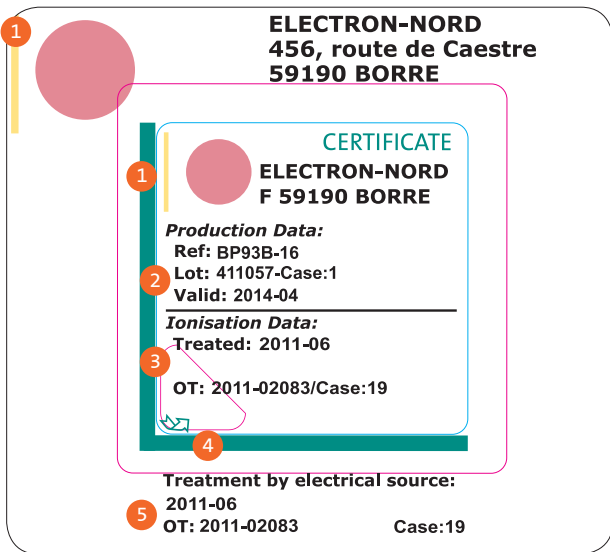

- 1 Sterilization indicator: becomes red after sterilization
- 2 Product information: reference, lot number
- 3 Sterilization information: date, carton number
- 4 Detachable certificate (for your records)
- 5 Details and information remain on the outer carton

### Product Label

The product label on the outside of each case clearly displays traceability information.

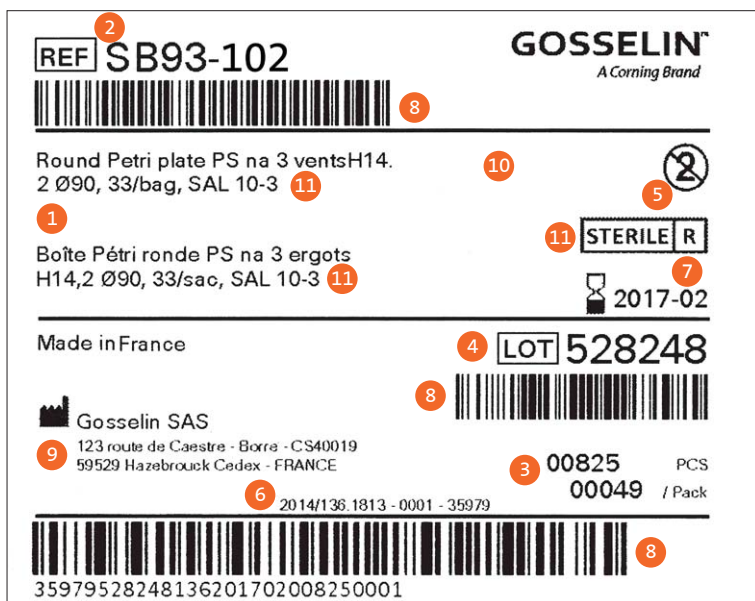

- 1 Product description in multiple languages
- 2 Product code
- 3 Quantity per case and per inner pack
- 4 Lot number
- 5 Single use symbol
- 6 Year, day, time of production, and case number
- 7 Expiration date
- 8 Bar codes
- 9 Manufacturing plant
- 10 IVD/CE - CE Mark if applicable
- 11 Sterility Assurance Level (SAL)

# Glossary

## Sterility Assurance Level (SAL)

### Sterile SAL $10^{-6}$

- ▶ Sterility obtained through use of ionizing radiation
- ▶ Sterilized to achieve a Sterility Assurance Level (SAL) of  $10^{-6}$
- ▶ Sterilization process is validated per standard AAMI/ANSI/ISO 11137

### Sterile SAL $10^{-3}$

- ▶ Sterility obtained through use of ionizing radiation
- ▶ Sterilized to achieve a Sterility Assurance Level (SAL) of  $10^{-3}$
- ▶ Sterilization performed at a lower dose than product with SAL  $10^{-6}$
- ▶ Sterilization process is validated per standard AAMI/ANSI/ISO 11137

### Aseptic

- ▶ Products are produced in a tightly controlled environment
- ▶ Fully automated manufacturing process from product molding to packaging
- ▶ Products that are aseptic do not have a Sterility Assurance Level (SAL).

### Standards

- ▶ ISO 11137: Sterilization of health care products – Radiation.
- ▶ Regulation REACH, no. 1907/2006/CE: Registration, Evaluation, Authorization and Restriction of Chemicals (REACH).
- ▶ Regulation (EC) no 1935/2004: on materials and articles intended to come into contact with food and repealing Directives 80/590/EEC and 89/109/EEC.
- ▶ 94/62/EC: The Directive aims to prevent or minimize the impact of packaging and packaging waste on the environment through recovery and recycling targets (absence of heavy metal).

## Alphabetical Index

	Page No.
<b>B</b>	
Bags, Autoclave .....	33
Bags, Blender .....	26
Bags, Clip .....	26
Blender .....	36
Bottles, Octagonal .....	16
Bottles, Square .....	17
Bottles, Round .....	18
<b>C</b>	
Containers, Straight .....	21
Containers, Clear Conical .....	22
Containers, White Conical .....	22
Cutlery .....	25
<b>D</b>	
Diluter .....	36
Dippers .....	25
Dishes, Contact .....	9
Dishes, Petri .....	9-11
Dishes, Seed Germination .....	11
Dishes, Square Petri .....	11
<b>E</b>	
Equipment .....	36
<b>L</b>	
Loops, Inoculating .....	28, 29
<b>P</b>	
Pipets, Straw .....	27
Pipets, Transfer .....	27
<b>S</b>	
Spreaders .....	30

## Catalog Number Index

Cat. No.	Page No.	Cat. No.	Page No.	Cat. No.	Page No.
BB60-01	9	FL60-04	21	PC400-03	22
BB64-01	9	FL100-05	21	PC400-05	22
BB64-02	9	FL300-04	21	PC400-09	22
BBAG-03	26	FOUR-01	25	PC1000-04	22
BBAG-04	26	LC150A-05	17	PC1000-05	22
BP53-03	9	LC250-06	17	S-Blender-1A	36
BP63-10	9	LC500-11	17	S-Diluter-1	36
BP93B-101	10	LC1000-13	17	SA03-01	33
BP93B-102	10	LC2000-03	17	SA03-10	33
BP93D-102	10	LC2500A-07	17	SA09-01	33
BP945-01	10	LR50A-18	18	SA09-10	33
BP94A-01	10	LR100-12	18	SA14-01	33
BP124-05	11	LR150A-14	18	SA14-10	33
BP143-06	11	LR250-09	18	SA21-01	33
BT93-02	11	LR500-04	18	SA21-10	33
BTX93-02	11	LR1000-08	18	SA33-01	33
CFM-01	25	OS1-01	29	SA33-10	33
CLIP-01	26	OS1B-01	28	SB93-101	10
COUT-02	25	OS10-02	29	SB93-102	10
CUIG-01	25	OS10B-02	28	SM1-01	26
CUIP-01	25	P125B-06	16	SM2-01	26
EPI1B-01	27	P125B-50	16	SM3-01	26
EPI1B-05	27	P250B-06	16	TAF1-01	25
EPI5-01	27	P250B-50	16	TAT30C-01	25
EPI24B-01	27	P500B-12	16	TAT52C-01	25
EPI24B-02	27	P500B-50	16	TAT53C-01	25
ETAR-01	30	P1000B-11	16	TP35C-002	21
ETAR-05	30	P1000B-50	16	TP35C-013	21
ETAT-04	30	PAS1A-01	27	TP52C-002	21
FBAG-03	26	PAS3A-01	27	TP53C-002	21
FBAG-04	26	PC200A-02	22		
FL52-02	21	PC200A-07	22		



For up-to-date information on the Corning® Gosselin™ brand comprehensive range of products and services, visit [www.corning.com/microbiology](http://www.corning.com/microbiology)



Corning® Gosselin™ has been a pioneering brand of disposable labware for microbiology since 1965.



[www.corning.com/lifesciences/solutions](http://www.corning.com/lifesciences/solutions)

For premium quality and performance in quality testing labs, you can count on Corning. In our continuous efforts to improve efficiencies and develop new tools for microbiology applications, we have scientists working in Corning labs doing what you do every day, across the globe. From sampling and preparation to bacteria growth and analysis, our technical experts understand your challenges and the changing regulatory requirements that shape your day-to-day processes.

It is this expertise, plus a 160-year legacy of Corning innovation and manufacturing excellence, that puts us in a unique position to be able to offer high quality, reliable microbiology consumables for quality testing labs. The introduction of our Corning Gosselin Microbiology product line has completed our portfolio, creating a beginning-to-end solutions for quality testing labs across industry segments.

For more specific information on claims, visit the Certificates page at [www.corning.com/lifesciences](http://www.corning.com/lifesciences).

**Warranty/Disclaimer:** Unless otherwise specified, all products are for research use only. Not intended for use in diagnostic or therapeutic procedures. Corning Life Sciences makes no claims regarding the performance of these products for clinical or diagnostic applications.

For additional product or technical information, visit [www.corning.com/lifesciences](http://www.corning.com/lifesciences) or call 800.492.1110. Outside the United States, call +1.978.442.2200 or contact your local Corning sales office.

**CORNING**

**Corning Incorporated**  
*Life Sciences*  
 836 North St.  
 Building 300, Suite 3401  
 Tewksbury, MA 01876  
 t 800.492.1110  
 t 978.442.2200  
 f 978.442.2476  
[www.corning.com/lifesciences](http://www.corning.com/lifesciences)

**ASIA/PACIFIC**  
**Australia/New Zealand**  
 t 61 427286832  
**China**  
 t 86 21 3338 4338  
 f 86 21 3338 4300  
**India**  
 t 91 124 4604000  
 f 91 124 4604099

**Japan**  
 t 81 3-3586 1996  
 f 81 3-3586 1291  
**Korea**  
 t 82 2-796-9500  
 f 82 2-796-9300  
**Singapore**  
 t 65 6572-9740  
 f 65 6861-2913  
**Taiwan**  
 t 886 2-2716-0338  
 f 886 2-2516-7500

**EUROPE**  
[CEurope@corning.com](mailto:CEurope@corning.com)  
**France**  
 t 0800 916 882  
 f 0800 918 636  
**Germany**  
 t 0800 101 1153  
 f 0800 101 2427  
**The Netherlands**  
 t 020 655 79 28  
 f 020 659 76 73  
**United Kingdom**  
 t 0800 376 8660  
 f 0800 279 1117

**All Other European Countries**  
 t +31 (0) 206 59 60 51  
 f +31 (0) 206 59 76 73  
**LATIN AMERICA**  
[grupoLA@corning.com](mailto:grupoLA@corning.com)  
**Brasil**  
 t 55 (11) 3089-7400  
**Mexico**  
 t (52-81) 8158-8400