

# Corning® Gosselin™ Product Selection Guide

Issue 8

CORNING



Quality  
products  
for reliable  
results

# Table of Contents

## Beginning-to-end Solutions for Microbiology ..... 1

Corning Gosselin Brand Products .....	1
Ask the Scientist .....	2
Quality Commitment .....	2
Glossary .....	3

## Contact and Petri Dishes ..... 4

Overview .....	5
Contact Dishes .....	6
Petri Dishes .....	6
Petri Dishes with 2 Compartments .....	8
Petri Dishes for Seed Germination .....	8
Petri Dishes, Square .....	8

## Bottles ..... 9

Overview .....	10
Features .....	10
Bottles, Octagonal .....	11
Bottles, Square .....	12
Bottles, Round .....	15
Bottles, Rectangular .....	16
Water Sampling .....	17
Bottles, Octagonal .....	18
Bottles, Square .....	19

## Containers ..... 21

Overview .....	22
Containers, Straight .....	23
Containers, Conical, Clear .....	26
Containers, Conical, White .....	26
Pots .....	27

## Tubes ..... 28

Tube Size Comparability Chart .....	29
Tubes, Round Bottom .....	30
Tubes, Flat Bottom, Polypropylene .....	32
Culture Tubes, Drosophila, Flat Bottom .....	32
Tubes, Conical Bottom, Polystyrene .....	32
Tubes, Conical Bottom, Polypropylene .....	33
Tubes, Conical Bottom, Skirted, Polypropylene .....	33
Tubes, Conical, Winged Bottom, Polystyrene .....	33

## Product Ordering Information

Products may not be available in all markets. For information on Purchasing Options, Terms and Conditions of Sale, Return and Repair Policies, and Warranty/Guarantee Registration, visit [www.corning.com/how-to-buy](http://www.corning.com/how-to-buy).

## Closures ..... 34

Overview .....	35
Features of Corning® Gosselin™ Tubes and Closures ...	35

## Sampling and Inoculation ..... 36

Overview .....	37
Dippers with Removable Handle .....	38
Cutlery .....	38
Blender Bags .....	39
Clip for Bags .....	39
Pipets, Straw .....	40
Pipets, Transfer .....	40
Inoculating Loops .....	41
Stirrers .....	42
Spreaders .....	42

## Transportation and Disposal ..... 43

Overview .....	44
Waste and Sharp Containers .....	45
Pipet Container .....	45
Bags .....	46
Resealable Bags, Double-pocket .....	46
Bag, Self-adhesive .....	46
Bags, Metal Closure .....	47
Bags, Autoclave .....	48
Slide Mailer .....	48
Recommendation: .....	48
Buckets .....	49
Tub .....	49

## Technical Appendix ..... 50

Features of Corning Gosselin Plasticware .....	51
Chemical Compatibility of Corning Gosselin Plasticware ..	52
Traceability .....	53
Ionization Certificate .....	53
Product Label .....	53

## Catalog Number Index ..... 54

# Beginning-to-end Solutions for Microbiology



For premium quality and performance in quality testing labs, you can count on Corning. In our continuous efforts to improve efficiencies and develop new tools for microbiology applications, we have scientists working in Corning labs doing what you do every day, across the globe. From sampling and preparation to bacteria growth and analysis, our technical experts understand your challenges and the changing regulatory requirements that shape your day-to-day processes.

It is this expertise, plus a 160-year legacy of Corning innovation and manufacturing excellence, that puts us in a unique position to be able to offer high quality, reliable microbiology consumables for quality testing labs. Our Corning® Gosselin™ line of consumables including Petri dishes, dippers and inoculating loops completes our portfolio, creating a beginning-to-end solution for quality testing labs across industry segments.

Corning Gosselin brand products are optimized for both food and beverage and environmental testing laboratories. The line of quality testing consumables complies with International Environmental standards, and includes a range of features to ensure traceability.

This product selection guide highlights the Corning products and brands which support the quality testing process at each stage.

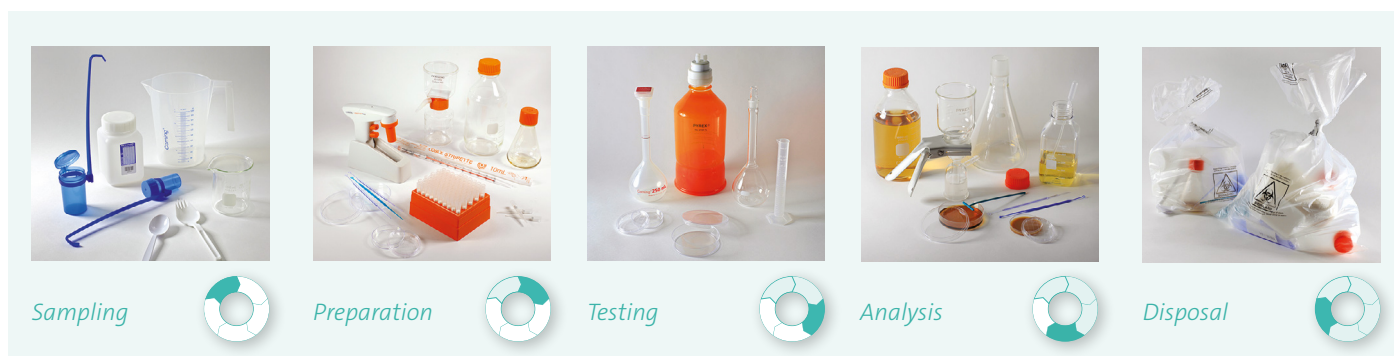

## Corning Gosselin Brand Products

Corning has been a pioneering brand of disposable labware for microbiology in Europe since 1965. Corning Gosselin products offer:

- ▶ A complete range of products to meet your testing needs
- ▶ Manufacturing facility is:
  - Raw materials/resins, compliancy with 94/62/EC and Registration, evaluation, authorization and restriction of chemicals (REACH) compliant
  - ISO 9001 certified
  - ISO 14001 certified
- ▶ Easily accessible traceability features such as:
  - Peelable labels with lot numbers, expiration date, and sterilization information to insert in your laboratory notebook
  - Sterilization treatment visual indicator on each case
  - Certificates of Compliance can be downloaded at [www.corning.com/resources](http://www.corning.com/resources).

## Scope of Applications



Food and Beverage



Environment



Pharmaceutical Industry



Dairy

## Ask the Scientist



Corning Scientific Support can help you succeed in any stage of your experiment. With a broad background in different life science disciplines, our support scientists offer valuable help for basic and advanced product support, designing new experiments, using the right product, and delivering the necessary product documentation.

### Scientific support at a glance

- ▶ Pre- and post-sales application support
- ▶ Protocol set up and optimization
- ▶ Help choosing the right product
- ▶ Product documentation and information
- ▶ Product certificates
- ▶ Lot-specific information and reservation
- ▶ Troubleshooting experiments and data

### We understand you

- ▶ We are scientists
- ▶ We offer extensive product experience
- ▶ We think out-of-the-box and try to find the best solution for you and your experiment

## Quality Commitment

### Corning® Gosselin™ SAS Facility Quality Commitment

Corning Gosselin SAS facility is ISO 9001 and ISO 14001 certified. The ISO certifications verify our facilities meet international quality system standards. ISO compliance gives our customers an added level of assurance that Corning is committed to continuous improvement. For more information visit [www.corning.com/resources](http://www.corning.com/resources).



## Glossary



### Sterility Assurance Level (SAL)

Sterile SAL of  $10^{-6}$

- ▶ Sterility obtained through use of ionizing radiation
- ▶ Sterilized to achieve a Sterility Assurance Level (SAL) of  $10^{-6}$
- ▶ Sterilization process is validated per standard AAMI/ANSI/ISO 11137

Sterile SAL of  $10^{-3}$

- ▶ Sterility obtained through use of ionizing radiation
- ▶ Sterilized to achieve a Sterility Assurance Level (SAL) of  $10^{-3}$
- ▶ Sterilization performed at a lower dose than product with SAL  $10^{-6}$
- ▶ Sterilization process is validated per standard AAMI/ANSI/ISO 11137

Aseptic

- ▶ Products are manufactured in a controlled environment, without human intervention during the manufacturing process.
- ▶ Finished products with an Aseptic claim are not subjected to sterilization and do not make a claim to have a Sterility Assurance Level.

### Standards

- ▶ ISO 11137: Sterilization of health care products – Radiation.
- ▶ Regulation REACH, no. 1907/2006/CE: Registration, Evaluation, Authorization and Restriction of Chemicals (REACH).
- ▶ Regulation (EC) no 1935/2004: on materials and articles intended to come into contact with food and repealing Directives 80/590/EEC and 89/109/EEC.
- ▶ 94/62/EC: The Directive aims to prevent or minimize the impact of packaging and packaging waste on the environment through recovery and recycling targets (absence of heavy metal).

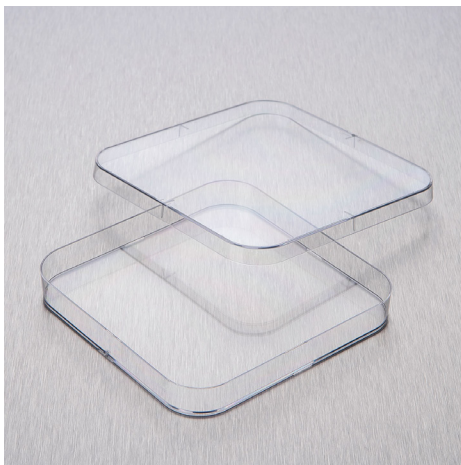

## Contact and Petri Dishes

Overview .....	5
Contact Dishes .....	6
Petri Dishes .....	6
Petri Dishes with 2 Compartments .....	8
Petri Dishes for Seed Germination .....	8
Petri Dishes, Square .....	8

## Overview



### Advantages of Corning® Gosselin™ Petri Dishes

- ▶ **Optimal flatness:** To ensure the agar's constant depth.
- ▶ **Adequate clarity:** The injection point situated on the side of the dish bottom optimizes reading even by image analyzing systems.
- ▶ **Lightness:** Thanks to research, we have been able to determine the ideal weight of our dishes in order to reduce our customers waste disposal costs while still pursuing our objective: to provide high quality dishes.
- ▶ **Stable stacking:** The stacking ring is specially designed to improve the stacking of dishes and making them more practical to use.
- ▶ **Class 100 manufacturing environment**
- ▶ **Product traceability:** Thanks to the product label on each box, we can trace each production cycle. This label includes the date and time of manufacturing, lot number, the Sterilization Assurance Level (SAL), and the expiration date.
- ▶ **Raw materials:** Compliant with the European directives (94/62/EC), food compatibility (1935/2004/CE and 10/2011/CE).

### Two Types of Packaging

#### One outer bag

Packaging type: Standard

Outer bag: 1

Packaging:

- ▶ Sleeves are placed directly in the case

#### Zero or double outer bags

Packaging type: Suitable for clean room use

Outer bag: 0 or 2

Packaging:

- ▶ Sleeves are placed in a sealed bag with bar code
- ▶ Bags are placed in a second folded bag
- ▶ Final packaging in a case

### Contact Dishes

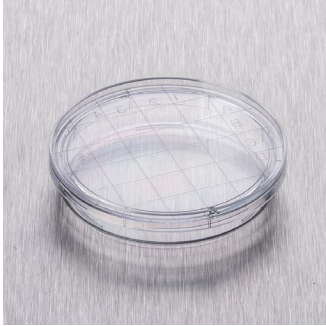

- ▶ 3 or 4 vents
- ▶ Crystal Polystyrene
- ▶ Molded grid 10 x 10 mm
- ▶ Easy opening
- ▶ Manufactured in class 100 environment

#### 65 x 14.5 mm (D x H)

Cat. No.	Vents	Description	Sterile	Units/Sleeve	Sleeves	Outer Bag	Qty/Cs
BP63-08	3	Flat bottom, grip lid	Yes	20	36	2	720
BP63-10	3	Flat bottom	Yes	20	36	2	720
BP63-11	3	Flat bottom	Aseptic	20	36	2	720
BB64-01	4	Domed bottom, grip lid	Yes	20	36	2	720
BB64-02	4	Domed bottom, grip lid	Aseptic	20	36	2	720



### Petri Dishes



- ▶ 0 or 6 vents
- ▶ Crystal Polystyrene
- ▶ Optimal flatness
- ▶ Save up to 19% agar while maintaining qualities of surface sampling
- ▶ Easy opening
- ▶ Manufactured in class 100 environment

#### 55 x 14.2 mm (D x H)

Cat. No.	Vents	Sterile	Units/Sleeve	Sleeves	Outer Bag	Qty/Cs
BP50-01	0	Aseptic	15	108	1	1620
BP50-02	0	Yes	15	108	1	1620
BP53-03	6	Yes	15	108	2	1620
BP53-06	6	Aseptic	15	108	2	1620

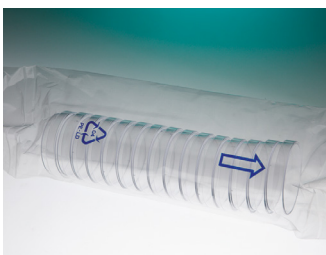

Arrows printed on recyclable sleeve to indicate the direction to open.



### Petri Dishes

- ▶ 0 or 3 vents
- ▶ Crystal Polystyrene
- ▶ Optimal flatness
- ▶ Easy opening
- ▶ Manufactured in class 100 environment

### Clean Packaging

#### 90 x 14 mm (D x H)

Cat. No.	Vents	Sterile	Units/Sleeve	Sleeves	Outer Bag	Qty/Cs
BP90B-101	0	Aseptic	33	25	2	825
BP90B-102	0	Yes	33	25	2	825
BP93B-101	3	Aseptic	33	25	2	825
BP93B-102	3	Yes	33	25	2	825

#### 90 x 16.2 mm (D x H)

Cat. No.	Vents	Sterile	Units/Sleeve	Sleeves	Outer Bag	Qty/Cs
BH90B-102	0	Yes	28	25	2	700
BH93B-102	3	Yes	28	25	2	700

#### 140 x 20.6 mm (D x H)

Cat. No.	Vents	Sterile	Units/Sleeve	Sleeves	Outer Bag	Qty/Cs
BP140-01	0	Aseptic	11	16	2	176
BP140-02	0	Yes	11	16	2	176
BP143-06	3	Yes	11	16	2	176
BP143-07	3	Aseptic	11	16	2	176

### General Lab Packaging

#### 90 x 14.2 mm (D x H)

Cat. No.	Vents	Sterile	Units/Sleeve	Sleeves	Outer Bag	Qty/Cs
SB90-101	0	Aseptic	33	25	0	825
SB93-101	3	Aseptic	33	25	0	825
SB93-102	3	Yes	33	25	0	825

#### 90 x 16.2 mm (D x H)

Cat. No.	Vents	Sterile	Units/Sleeve	Sleeves	Outer Bag	Qty/Cs
SH90-101	0	Aseptic	28	25	0	700
SH93-101	3	Aseptic	28	25	0	700



Arrows printed on recyclable sleeve to indicate the direction to open.

### Petri Dishes with 2 Compartments



- ▶ 3 vents
- ▶ 2 compartments
- ▶ Crystal Polystyrene
- ▶ Optimal flatness
- ▶ Frosted area
- ▶ Easy opening\*
- ▶ Manufactured in class 100 environment

**90 x 14.2 mm (D x H)**

Cat. No.	Vents	Sterile	Units/Sleeve	Sleeves	Outer Bag	Qty/Cs
BI93D-101	3	Aseptic	33	25	2	825
BI93D-102	3	Yes	33	25	2	825

\*Allows indexing to facilitate automated pouring of media into their respective compartments.

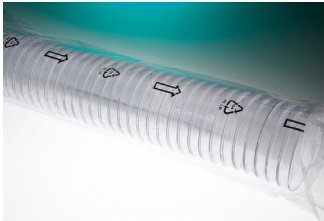

### Petri Dishes for Seed Germination



- ▶ Ideal for seed germination
- ▶ 3 vents
- ▶ Crystal Polystyrene
- ▶ Optimal flatness
- ▶ Easy opening
- ▶ Manufactured in class 100 environment

**100 x 25 mm (D x H)**

Cat. No.	Vents	Sterile	Units/Sleeve	Sleeves	Outer Bag	Qty/Cs
BT93-02	3	Yes	10	50	0	500

### Petri Dishes, Square



- ▶ 4 vents
- ▶ Crystal Polystyrene
- ▶ Optimal flatness
- ▶ Easy opening
- ▶ Manufactured in class 100 environment

**120 x 120 mm (W x D)**

Cat. No.	Vents	Sterile	Units/Sleeve	Sleeves	Outer Bag	Qty/Cs
BP124-04	4	Aseptic	14	18	2	252
BP124-05	4	Yes	14	18	2	252



## Bottles

- Overview ..... 10
- Features ..... 10
- Bottles, Octagonal ..... 11
- Bottles, Square ..... 12
- Bottles, Round ..... 15
- Bottles, Rectangular ..... 16
- Water Sampling ..... 17
  - Bottles, Octagonal ..... 18
  - Bottles, Square ..... 19

## Overview



### Advantages of Corning® Gosselin™ Bottles

- Manufacturing process:** All bottles are produced with advanced equipment using extrusion blow molding or injection blow molding technology. Each production lot is subject to inspection throughout the entire production process according to the normative references, which are reinforced by Corning's own specifications.
- Bottle shapes:** Corning offers a wide range of bottles: octagonal, round, square, and rectangular. Bottles are available from 30 to 2700 mL, with narrow or wide necks, and many have molded graduations.
- Closure systems:** Various closure systems are available, from simple screw caps to tamper-evident hinged caps. All closures are designed with vertical ribs to improve handling.
- Packaging:** Our packaging is designed to suit your needs, with individually bagged or pre-assembled bottles wrapped in packs or trays. All bottles are protected by a Polyethylene outer bag within the box to reduce the risk of particle contamination.
- Product traceability:** Product labels on each box allow us to trace each production cycle. This label includes the date and time of manufacturing, lot number, and the expiration date for sterilized products.
- Raw materials:** Compliant with the European directives (94/62/EC) and food compatibility (1935/2004/EC and 10/2011/EC).

## Features

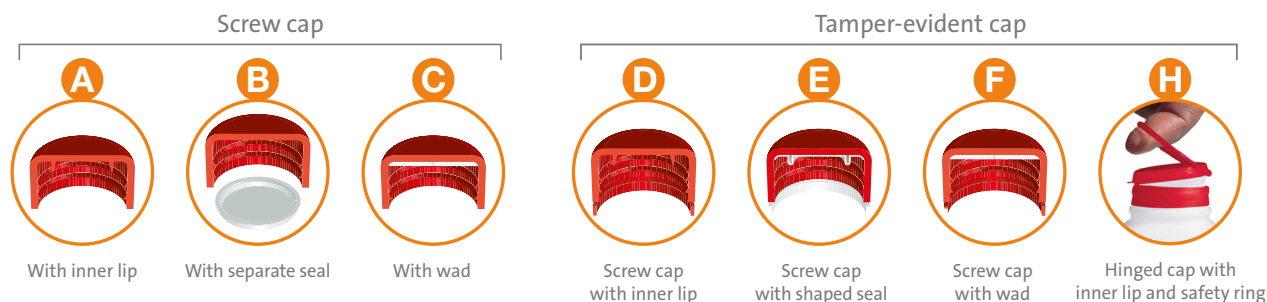

### PET Bottles, Filmed Packaging

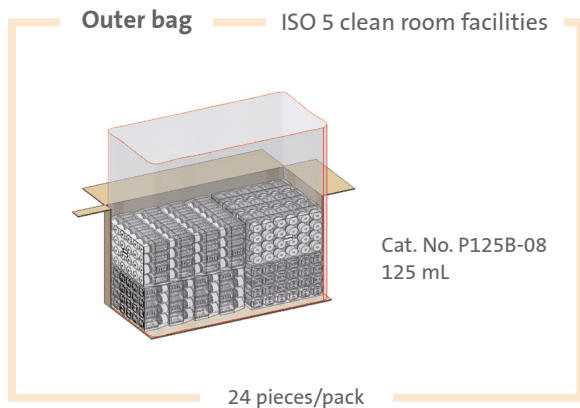

### Bottles, Octagonal



Example of use: microbiological media packaging.

- ▶ Polyethylene terephthalate (PET) bottles
- ▶ Break-resistant
- ▶ Molded graduations
- ▶ Ergonomic shape for easy handling
- ▶ Leak-proof, tamper-evident HDPE screw cap
- ▶ Transparent as glass
- ▶ Sterility Assurance Level (SAL) of 10<sup>-3</sup>





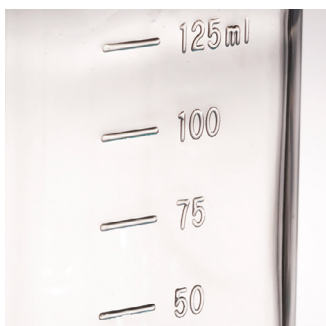





All packs have traceability label.



Molded graduations.









#### Filmed Pack with Assembled Cap

Cat. No.	Volume (ml)	A (mm)	B (mm)	C (mm)	Cap Type	Sterile	Qty/Cs
P125B-50	125	107	53 x 53	32	 	Yes	336
P250B-50	250	135	64 x 64	32	 	Yes	144
P500B-50	500	172	75 x 75	32	 	Yes	120
P1000B-50	1000	214	97 x 97	32	 	Yes	48

#### Filmed Pack with Pre-assembled Cap

P125B-08	125	107	53 x 53	32	 	Yes	336
----------	-----	-----	---------	----	---	-----	-----

#### Filmed Pack with Non-assembled Cap

P125B-05	125	107	53 x 53	32	 	No	288
P250B-01	250	135	64 x 64	32	 	No	144
P500B-09	500	172	75 x 75	32	 	No	120
P1000B-06	1000	214	97 x 97	32	 	No	48

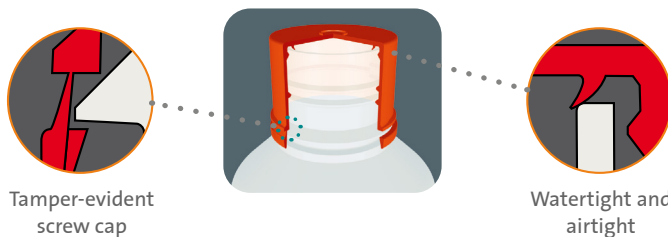

#### Bottle Dimension Key

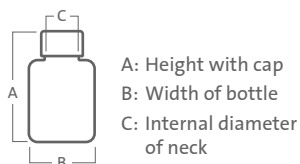











Tamper-evident screw cap with inner lip

### Bottles, Square

















- ▶ High-density polyethylene (HDPE) bottles
- ▶ Break-resistant
- ▶ Bulk packed in one folded outer bag
- ▶ Other cap colors are available for certain products
- ▶ Sterility Assurance Level (SAL) of 10<sup>-3</sup>

#### Translucent, Screw Cap with Wide Mouth

Cat. No.	Volume (mL)	A (mm)	B (mm)	C (mm)	Cap Type	Sterile	Qty/Cs
LC150A-03	150	95	50 x 50	37	 	No	300
LC150A-04	150	95	50 x 50	37	 	No	300
LC150A-05	150	95	50 x 50	37	 	Yes	300
LC150A-07	150	95	50 x 50	37	 	No	300
LC150A-09	150	95	50 x 50	37	 	Yes	300



#### Translucent, Molded Graduations, Screw Cap with Wide Mouth

Cat. No.	Volume (mL)	A (mm)	B (mm)	C (mm)	Cap Type	Sterile	Qty/Cs
LC250-01	250	109	57 x 57	37	 	No	210
LC250-02	250	109	57 x 57	37	 	Yes	210
LC250-03	250	109	57 x 57	37	 	No	210
LC250-04	250	109	57 x 57	37	 	Yes	210
LC250-06	250	109	57 x 57	37	 	Yes	210
LC250-10	250	109	57 x 57	37	 	No	210
LC250-20*	250	109	57 x 57	37	 	Yes	182

\*Individually bagged.

#### Bottle Dimension Key

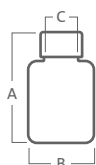

A: Height with cap  
 B: Width of bottle  
 C: Internal diameter of neck

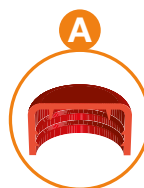

Screw cap with inner lip



Screw cap with separate seal



Screw cap with wad

### Bottles, Square



#### Translucent, Molded Graduations, Screw Cap with Wide Neck

Cat. No.	Volume (ml)	A (mm)	B (mm)	C (mm)	Cap Type	Sterile	Qty/Cs
LC500-01	500	122	76 x 76	58	B	No	175
LC500-02	500	122	76 x 76	58	B	Yes	175
LC500-03	500	122	76 x 76	58	A	Yes	175
LC500-04	500	122	76 x 76	58	A	No	175
LC500-07	500	122	76 x 76	58	C	No	175
LC500-11	500	122	76 x 76	58	C	Yes	175
LC1000-01	1000	185	95 x 76	58	B	No	90
LC1000-02	1000	185	95 x 76	58	B	Yes	90
LC1000-04	1000	185	95 x 76	58	A	No	90
LC1000-06	1000	185	95 x 76	58	A	Yes	90
LC1000-07	1000	185	95 x 76	58	C	No	90
LC1000-13	1000	185	95 x 76	58	C	Yes	90
LC2000-01	2000	230	109 x 96	58	B	No	50
LC2000-03	2000	230	109 x 96	58	B	Yes	50
LC2000-05	2000	230	109 x 96	58	C	No	50
LC2000-07	2000	230	109 x 96	58	A	No	50
LC2000-08	2000	230	109 x 96	58	A	Yes	50
LC2000-17	2000	230	109 x 96	58	C	Yes	50



#### Translucent or Brown, Molded Graduations, Screw Cap with Wide Neck, Nonsterile

Cat. No.	Volume (ml)	A (mm)	B (mm)	C (mm)	Cap Type	Qty/Cs
F2000-02	2000	230	110 x 95	73	C	50
F2000-12	2000	230	110 x 95	73	C	50

#### Bottle Dimension Key

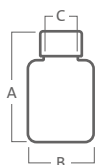



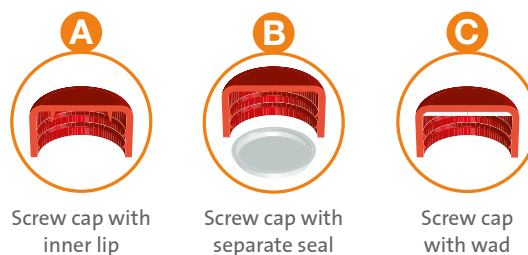









A: Height with cap  
 B: Width of bottle  
 C: Internal diameter of neck



### Bottles, Square























#### Translucent, Molded Graduations

Cat. No.	Volume (mL)	A (mm)	B (mm)	C (mm)	Cap Type	Sterile	Qty/Cs
FC510-02	500	148	70 x 70	29	 	Yes	100
FC520-02	500	148	70 x 70	22	 	Yes	100
FC520-08	500	148	70 x 70	22	 	No	100
FC500-03	500	148	70 x 70	37	 	Yes	100
FC1000-50	1000	182	82 x 82	28	 	No	77
FC1000-52	1000	182	82 x 82	28	 	Yes	77



#### Translucent, Screw Cap with Narrow Neck, Nonsterile

Cat. No.	Volume (mL)	A (mm)	B (mm)	C (mm)	Cap Type	Qty/Cs
FCP100-01	100	103	39 x 39	20	 	300
FCP100-02	100	103	39 x 39	20	 	300
FCP250-02	250	128	55 x 55	20	 	194
FCP250-03	250	128	55 x 55	20	 	208
FCP500-02	500	149	70 x 70	20	 	100
FCP500-04	500	149	70 x 70	20	 	100
FCP1000-03	1000	184	89 x 89	20	 	60
FCP1000-04	1000	184	89 x 89	20	 	60
FCP2000-03	2000	224	113 x 113	26	 	45
FCP2000-04	2000	224	113 x 113	26	 	45



#### Bottle Dimension Key

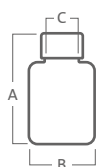

A: Height with cap  
 B: Width of bottle  
 C: Internal diameter of neck

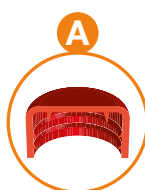

Screw cap with inner lip

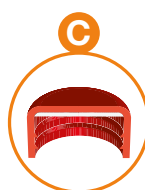

Screw cap with wad



Tamper-evident screw cap with shaped seal



Tamper-evident hinged cap with inner lip and safety ring



### Bottles, Round

- ▶ High-density polyethylene (HDPE) bottles
- ▶ Break-resistant
- ▶ Bulk packed in one folded outer bag
- ▶ Other cap colors are available for certain products
- ▶ Sterility Assurance Level (SAL) of 10<sup>-3</sup>



### Translucent, Molded Graduations

Cat. No.	Volume (mL)	A (mm)	B (mm)	C (mm)	Cap Type	Sterile	Qty/Cs
LR50A-01	50	77	36	27	B	No	600
LR50A-02	50	77	36	27	A	No	600
LR50A-05	50	77	36	27	B	Yes	600
LR50A-12	50	77	36	27	C	No	600
LR50A-18	50	77	36	27	C	Yes	600
LR100-01	100	80	51	37	B	No	335
LR100-03	100	80	51	37	B	Yes	335
LR100-04	100	80	51	37	A	No	335
LR100-05	100	80	51	37	C	No	335
LR100-12	100	80	51	37	C	Yes	335
LR100-13	100	80	51	37	A	Yes	335
LR150A-01	150	108	51	37	B	No	250
LR150A-02	150	108	51	37	A	Yes	250
LR150A-03	150	108	51	37	A	No	250
LR150A-04	150	108	51	37	B	Yes	250
LR150A-07	150	108	51	37	C	No	250
LR150A-14	150	108	51	37	C	Yes	250
LR250-01	250	125	60	37	B	No	145
LR250-02	250	125	60	37	A	No	145
LR250-04	250	125	60	37	C	No	145
LR250-06	250	125	60	37	B	Yes	145
LR250-07	250	125	60	37	A	Yes	145
LR250-09	250	125	60	37	C	Yes	145
LR500-01	500	136	80	58	B	No	140
LR500-02	500	136	80	58	A	Yes	140
LR500-03	500	136	80	58	B	Yes	140
LR500-04	500	136	80	58	C	Yes	140
LR500-05	500	136	80	58	A	No	140
LR500-06	500	136	80	58	C	No	140

### Bottle Dimension Key

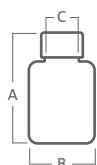

A: Height with cap  
 B: Width of bottle  
 C: Internal diameter of neck

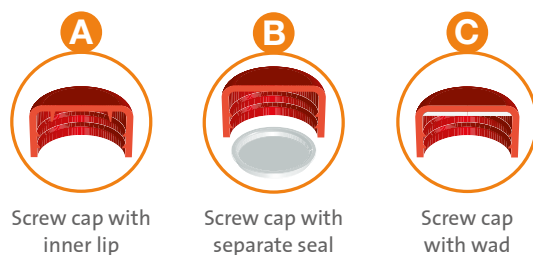

### Bottles, Round



Cat. No.	Volume (ml)	A (mm)	B (mm)	C (mm)	Cap Type	Sterile	Qty/Cs
LR1000-01	1000	174	101	58		No	68
LR1000-02	1000	174	101	58		Yes	68
LR1000-03	1000	174	101	58		No	68
LR1000-04	1000	174	101	58		No	68
LR1000-05	1000	174	101	58		Yes	68
LR1000-08	1000	174	101	58		Yes	68
LR2000-01	2000	220	121	57		No	25
LR2000-02	2000	220	121	57		Yes	25
LR2000-03	2000	220	121	57		No	25

### Bottles, Rectangular



- ▶ High-density polyethylene (HDPE) or Polypropylene (PP) bottles
- ▶ Break-resistant
- ▶ Reverse graduations
- ▶ Leakproof closure system
- ▶ Tamper-evident screw cap
- ▶ Bulk packed in one folded outer bag
- ▶ Other cap colors are available for certain products
- ▶ Sterility Assurance Level (SAL) of 10<sup>-3</sup>

#### Translucent, HDPE

Cat. No.	Volume (ml)	A (mm)	B (mm)	C (mm)	Cap Type	Sterile	Qty/Cs
FV250-15	250	155	60 x 45	20		No	312
FV250-09	250	155	60 x 45	20		No	312
FV250-05	250	155	60 x 45	20		Yes	312
FV500-04	500	200	72 x 52	20		Yes	170
FV500-05	500	200	72 x 52	20		No	170

#### Translucent, PP

Cat. No.	Volume (ml)	A (mm)	B (mm)	C (mm)	Cap Type	Sterile	Qty/Cs
FV250-02	250	155	60 x 45	20		Yes	312
FV500-09	500	200	72 x 52	20		Yes	170
FV500-14*	500	200	72 x 52	20		Yes	100

\*Individually wrapped.

#### Bottle Dimension Key

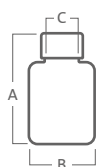

A: Height with cap  
 B: Width of bottle  
 C: Internal diameter of neck

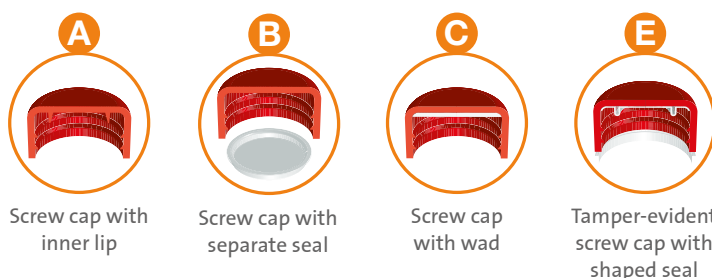

## Water Sampling





- ▶ Polyethylene terephthalate (PET) is transparent and break-resistant
- ▶ Molded graduations for accurate volume sample collection
- ▶ Powdered sodium thiosulfate is easier to dissolve than tablets
- ▶ Labeled with lot number, expiration date, and sodium thiosulfate dosage information
- ▶ Wide neck for easier sample collection
- ▶ Easy-grip cap
- ▶ Tamper-evident screw cap to ensure integrity until collection
- ▶ Sterile

### Labels

- ▶ Traceable
- ▶ Clearly visible sterility level
- ▶ Clear label distinction
  - Blue labels for natural non-chlorinated water
  - Red and green labels for chlorinated water
- ▶ Designated area for essential information
- ▶ 128 EAN bar code for product traceability

### Standards

Certified with the following standards:













	<b>ISO 5667-3</b>	Quality of water for water sampling Part 3: Guidelines for preservation and handling for water sampling
	<b>ISO 19458</b>	Quality of water for water sampling for microbiology analysis



### Bottles, Octagonal









- ▶ Polyethylene terephthalate (PET) bottles
- ▶ Break-resistant
- ▶ Transparent as glass
- ▶ Molded graduations
- ▶ Label for traceability
- ▶ Tamper-evident screw cap
- ▶ Sterility Assurance Level (SAL) of 10<sup>-3</sup>

#### With Na<sub>2</sub>S<sub>2</sub>O<sub>3</sub>·5H<sub>2</sub>O

Cat. No.	Volume (ml)	A (mm)	B (mm)	C (mm)	Cap Type	Sterile	Thiosulfate Sodium (mg/L)	Qty/Cs
HP250B-50**	250	135	64 x 64	32	 	Yes	20	144
HP250B-51**	250	135	64 x 64	32	 	Yes	120	144
HP250B-53*	250	135	64 x 64	32	 	Yes	120	150
HP500B-50**	500	172	75 x 75	32	 	Yes	20	120
HP500B-51**	500	172	75 x 75	32	 	Yes	120	120
HP1000B-53*	1000	214	97 x 97	32	 	Yes	120	45

\*1/Bag.  
\*\*Filmed pack.

#### Without Na<sub>2</sub>S<sub>2</sub>O<sub>3</sub>·5H<sub>2</sub>O

Cat. No.	Volume (ml)	A (mm)	B (mm)	C (mm)	Cap Type	Sterile	Thiosulfate Sodium (mg/L)	Qty/Cs
P250B-51**	250	135	64 x 64	32	 	Yes	–	144
P500B-51**	500	172	75 x 75	32	 	Yes	–	120
P1000B-51**	1000	214	97 x 97	32	 	Yes	–	48
P1000B-52*	1000	214	97 x 97	32	 	Yes	–	45

\*1/Bag.  
\*\*Filmed pack.

#### Bottle Dimension Key

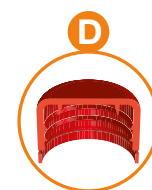
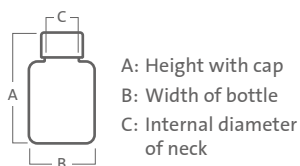

















Tamper-evident screw cap with inner lip

### Bottles, Square

- ▶ High-density polyethylene (HDPE) bottles
- ▶ Break-resistant
- ▶ Graduated surface
- ▶ Translucent
- ▶ Tamper-evident label or cap
- ▶ Bulk packed in one folded outer bag

#### With Na<sub>2</sub>S<sub>2</sub>O<sub>3</sub>·5H<sub>2</sub>O

Cat. No.	Volume (mL)	A (mm)	B (mm)	C (mm)	Cap Type	Sterile	Thiosulfate Sodium (mg/L)	Qty/Cs
HLC250-01	250	109	57 x 57	37	 	Yes	20	210
HLC250-02*	250	109	57 x 57	37	 	Yes	20	182
HFV250-01	250	155	60 x 45	20	 	Yes	20	312
HFV250-02*	250	155	60 x 45	20	 	Yes	20	200
HLC500-11	500	128	75 x 75	58	 	Yes	20	175
HLC1000-11	1000	187	92 x 77	58	 	Yes	20	90
HLC1000-12	1000	187	92 x 77	58	 	Yes	120	90
HLC2000-11	2000	237	110 x 93	58	 	Yes	20	50

\*1/Bag.



#### Bottle Dimension Key

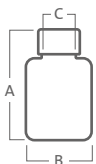

A: Height with cap  
 B: Width of bottle  
 C: Internal diameter of neck



Screw cap with wad



Tamper-evident screw cap with shaped seal



Tamper-evident label, screw cap with wad



### Bottles, Square

- ▶ High-density polyethylene (HDPE) bottles
- ▶ Break-resistant
- ▶ Tamper-evident leakproof screw cap
- ▶ Translucent
- ▶ Label for traceability
- ▶ Molded graduations
- ▶ Bulk packed in one folded outer bag
- ▶ Sterility Assurance Level (SAL) of 10<sup>-3</sup>

#### With Na<sub>2</sub>S<sub>2</sub>O<sub>3</sub>·5H<sub>2</sub>O

Cat. No.	Volume (mL)	A (mm)	B (mm)	C (mm)	Cap Type	Sterile	Thiosulfate Sodium (mg/L)	Qty/Cs
HFC500-01	500	146	70 x 70	37		Yes	20	100
HFC510-01	500	148	70 x 70	29		Yes	20	100
HFC510-02	500	148	70 x 70	29		Yes	120	100
HFC510-03*	500	148	70 x 70	29		Yes	20	100
HFC510-04*	500	148	70 x 70	29		Yes	120	100
HFC520-01	500	160	70 x 70	22		Yes	20	100
HFC520-06	500	160	70 x 70	22		Yes	120	100
HFC520-02*	500	160	70 x 70	22		Yes	20	100
HFC520-07*	500	160	70 x 70	22		Yes	120	100
HFC1000-50	1000	182	82 x 82	28		Yes	20	77
HFC1000-51	1000	182	82 x 82	28		Yes	120	77
HFC1000-53*	1000	182	82 x 82	28		Yes	20	77
HFC1000-52*	1000	182	82 x 82	28		Yes	120	77

\*1/Bag.



#### Without Na<sub>2</sub>S<sub>2</sub>O<sub>3</sub>·5H<sub>2</sub>O (Diam. 32 mm)

Cat. No.	Volume (mL)	A (mm)	B (mm)	C (mm)	Cap Type	Sterile	Thiosulfate Sodium (mg/L)	Qty/Cs
FC500-12	500	146	70 x 70	37		Yes	–	100
FC510-07	500	148	70 x 70	29		Yes	–	100
FC520-12	500	160	70 x 70	22		Yes	–	100
FC1000-18	1000	182	82 x 82	28		Yes	–	77

#### Bottle Dimension Key

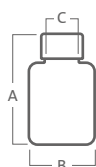

A: Height with cap  
 B: Width of bottle  
 C: Internal diameter of neck

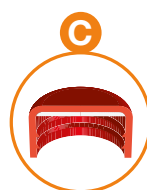

Screw cap with wad



Tamper-evident screw cap with shaped seal



Hinged cap with inner lip and safety ring



## Containers

Overview .....	22
Containers, Straight .....	23
Containers, Conical, Clear .....	26
Containers, Conical, White .....	26
Pots .....	27

## Overview

### Advantages of Corning® Gosselin™ Containers

- ▶ **Manufacturing process:** All containers are produced with high-tech equipment using molding technology. Most of our products are assembled in line to avoid any external contaminations. The raw plastics used are virgin and comply with the environmental standards in force. Each production lot is subject to inspection throughout the entire production process according to the standard referenced, which are reinforced by Corning's own specifications.
- ▶ **Container shape:** A wide range of straight containers, conical containers, and pots to meet customers' requirements. Containers are available from 25 mL to 1000 mL.
- ▶ **Closure systems:** Closure systems for our containers are suitable for normal use. Closure systems are available with hinged caps, screw caps, or snap caps.
- ▶ **Packaging:** Perfectly adapted to the user's needs: single bag, packing of containers into boxes, screw-capped containers wrapped on trays. All containers are protected by a Polyethylene outer bag placed inside the boxes beforehand to avoid particle contamination.
- ▶ **Product traceability:** Thanks to the product label on each box, we can retrace each production cycle. This label includes date and time of manufacturing, lot number, and expiry date if the product has been sterilized.
- ▶ **Raw materials:** Compliant with European directives, including the absence of heavy metals (94/62/EC). Raw materials of containers are food contact grade (comply with 1935/2004/EC and 10/2011/EC)\*

\*Corning suppliers guarantee the quality of their raw materials through a certificate of compliance. However, the finished products have not been validated for food contact applications. They are designed for laboratory applications only.



**Products compliant with international standards**

**Wide scope of applications**

**Range of products suitable worldwide**

**Packaging suitable for users' needs**



## Containers, Straight

- ▶ Auto-stable hinged cap
- ▶ Containers and caps made of Polypropylene (PP)
- ▶ Shock resistant
- ▶ With or without writing area
- ▶ Bulk packed in one folded outer bag

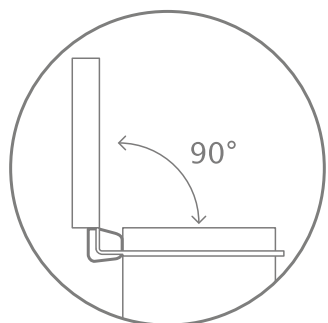

Auto-stable cap

### Transparent, Hinged Cap

Cat. No.	Volume (mL)	Height (mm)	Diam. (mm)	Cap Type	Writing Area	Sterile	Qty/Cs
FL35-02	35	66	28		No	No	950
FL52-01	45	85	29		Yes	No	650
FL60-01*	50	78	31		Yes	No	650
FL60-04*	50	78	31		Yes	Yes	650
FL100-01*	90	80	43		Yes	No	350
FL100-05*	90	80	43		Yes	Yes	350
FL300-01*	300	88	75		No	No	240
FL300-04*	300	88	75		No	Yes	240

\*FL60 graduated every 10 mL, FL100 graduated at 80 mL, FL300 graduated every 25 mL.

### Blue, Hinged Cap with Anti-drip Lip

Cat. No.	Volume (mL)	Height (mm)	Diam. (mm)	Cap Type	Writing Area	Sterile	Qty/Cs
FL60-05*	50	78	31		Yes	No	650
FL100-04*	90	80	43		Yes	No	350
FL300-02*	300	88	75		No	No	240

\*FL60 graduated every 10 mL, FL100 graduated at 80 mL, FL300 graduated every 25 mL.



**Containers, Straight**

- ▶ Clear, white, or blue Polypropylene (PP) containers
- ▶ Polyethylene screw-cap
- ▶ 4 cap colors: blue, green, red, and white
- ▶ Traceability on each product
- ▶ Bulk packed in one folded outer bag

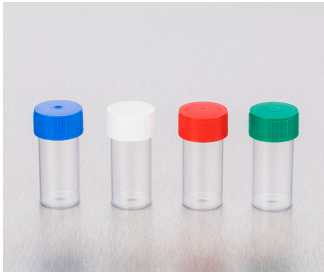

**Transparent, Hinged Cap**

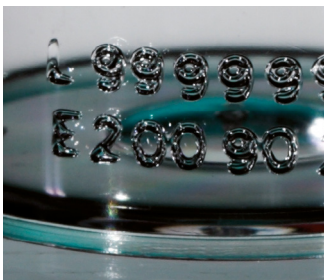

Lot number and expiry date laser marking on each container without label.

Cat. No.	Volume (mL)	Height (mm)	Diam. (mm)	Cap Type	Sterile	Qty/Bag	Qty/Cs
TP30C-002	40	70	30		Yes	100	1000
TP30C-032*	40	70	30		Yes	100	1000
TP30C-004	40	70	30		Yes	100	1000
TP30C-003	40	70	30		Yes	100	1000
TP30C-001	40	70	30		Yes	100	1000
TP30C-021*	40	70	30		Yes	100	1000
TP30C-012	40	70	30		No	100	1000
TP30C-014	40	70	30		No	100	1000
TP30C-013	40	70	30		No	100	1000
TP30C-011	40	70	30		No	100	1000
TP35C-032*	60	70	33		Yes	70	700
TP35C-002	60	70	33		Yes	70	700
TP35C-062*	60	70	33		Yes	30/tray	600
TP35C-052	60	70	33		Yes	30/tray	600
TP35C-042	60	70	33		Yes	1	500
TP35C-025**†	60	70	33		Yes	70	700
TP35C-004	60	70	33		Yes	70	700
TP35C-021*	60	70	33		Yes	70	700
TP35C-001	60	70	33		Yes	70	700
TP35C-012	60	70	33		No	70	700
TP35C-014	60	70	33		No	70	700
TP35C-013	60	70	33		No	70	700
TP35C-011	60	70	33		No	70	700

\*White label.  
 \*\*Includes spatula.  
 †White container.

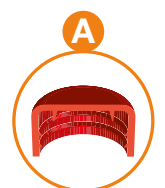

Screw cap with inner lip

## Containers, Straight



Cat. No.	Volume (mL)	Height (mm)	Diam. (mm)	Cap Type	Sterile	Qty/Bag	Qty/Cs
TP52C-002	125	74	52		Yes	380	380
TP52C-032*	125	74	52		Yes	380	380
TP52C-023**†	125	74	52		Yes	380	380
TP52C-024†	125	74	52		No	380	380
TP52C-025†	125	74	52		No	380	380
TP52C-004	125	74	52		Yes	380	380
TP52C-003	125	74	52		Yes	380	380
TP52C-001	125	74	52		Yes	380	380
TP52C-021*	125	74	52		Yes	380	380
TP52C-012	125	74	52		No	380	380
TP52C-022**†	125	74	52		No	380	380
TP52C-014	125	74	52		No	380	380
TP52C-013	125	74	52		No	380	380
TP52C-011	125	74	52		No	380	380
TP53C-002	180	102	52		Yes	264	264
TP53C-032*	180	102	52		Yes	264	264
TP53C-052**	180	102	52		Yes	264	264
TP53C-042	180	102	52		Yes	1	200
TP53C-004	180	102	52		Yes	264	264
TP53C-003	180	102	52		Yes	264	264
TP53C-001	180	102	52		Yes	264	264
TP53C-021*	180	102	52		Yes	264	264
TP53C-012	180	102	52		No	264	264
TP53C-023†	180	102	52		No	264	264
TP53C-014	180	102	52		No	264	264
TP53C-013	180	102	52		No	264	264
TP53C-011	180	102	52		No	264	264
TP200-02	200	100	55		No	162	162
TP200-14	200	100	55		Yes	162	162

\*White label.

\*\*Includes spatula.

†White container.

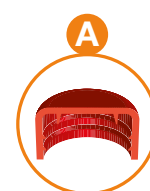

Screw cap with inner lip



### Containers, Conical, Clear

- ▶ Clear Polypropylene (PP) containers
- ▶ Polyethylene snap cap
- ▶ Molded graduations
- ▶ Bulk packed in one folded outer bag

Cat. No.	Volume (mL)	Height (mm)	Diam. (mm)	Cap Type	Sterile	Qty/Cs
PC200A-05	200	88	62		No	660
PC200A-03	200	88	62		No	220
PC200A-02	200	88	62		Yes	220
PC200A-01	200	88	62		No	660
PC400-06	400	100	85		No	460
PC400-09	400	100	85		No	185
PC400-03	400	100	85		Yes	185
PC400-01	400	100	85		No	460
PC1000-03	1000	130	105		No	250
PC1000-09	1000	130	105		No	120
PC1000-05	1000	130	105		Yes	80
PC1000-02	1000	130	105		No	250

### Containers, Conical, White

- ▶ White Polypropylene (PP) containers
- ▶ Clear polyethylene leakproof snap cap
- ▶ Molded internal graduations
- ▶ Bulk packed in one folded outer bag











Cat. No.	Volume (mL)	Height (mm)	Diam. (mm)	Cap Type	Sterile	Qty/Cs
PC200A-11	200	88	62		No	660
PC200A-07	200	88	62		Yes	220
PC200A-04	200	88	62		No	660
PC400-05	400	100	85		Yes	185
PC400-02	400	100	85		No	460
PC1000-11	1000	130	105		No	120
PC1000-04	1000	130	105		Yes	80
PC1000-13	1000	130	105		No	250

## Pots

- ▶ White Polypropylene (PP) or Polystyrene (PS) pots
- ▶ Polypropylene screw-cap
- ▶ Highly shock resistant
- ▶ Bulk packed in one folded outer bag
- ▶ Nonsterile

### White, Polypropylene

Cat. No.	Volume (mL)	Height (mm)	Diam. (mm)	Cap Type	Qty/Cs
PV30-01	30	32	40		500
PV75-01	75	67	41		400
PV125-01	125	60	54		300
PV500-01	500	98	83		90
PR500-02*	500	72	101		160
PR800-01*	775	106	101		100
PR1050-01*	1000	138	100		80
PR1000-01*	1070	106	120		90
PR1000-02*	1070	106	120		70

\*With seal.

### White, Polystyrene

Cat. No.	Volume (mL)	Height (mm)	Diam. (mm)	Cap Type	Qty/Cs
PV100-24	100	48	54		300



Seal



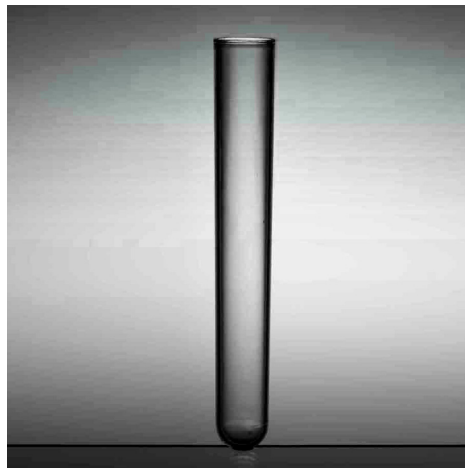

## Tubes

Tube Size Comparability Chart .....	29
Tubes, Round Bottom .....	30
Tubes, Flat Bottom .....	32
Culture Tubes, Drosophila, Flat Bottom.....	32
Tubes, Conical Bottom .....	32
Tubes, Conical Bottom, Polypropylene.....	33
Tubes, Skirted, Conical Bottom, Polypropylene.....	33
Tubes, Conical, Winged Bottom, Polystyrene (PS).....	33

## Tube Size Comparability Chart

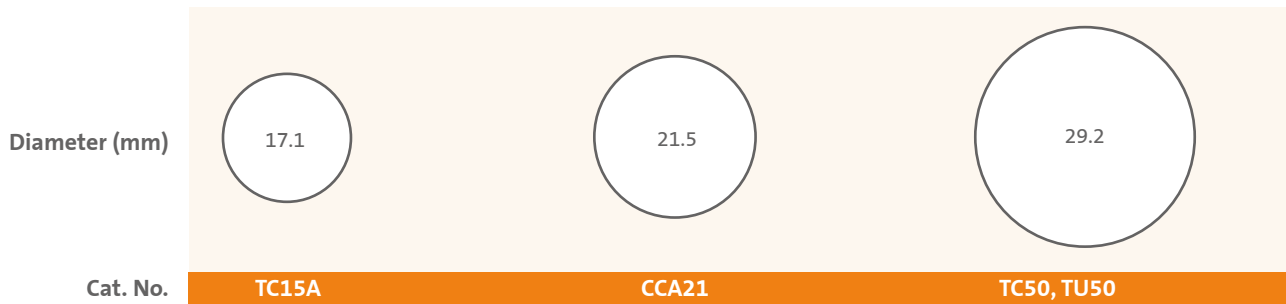
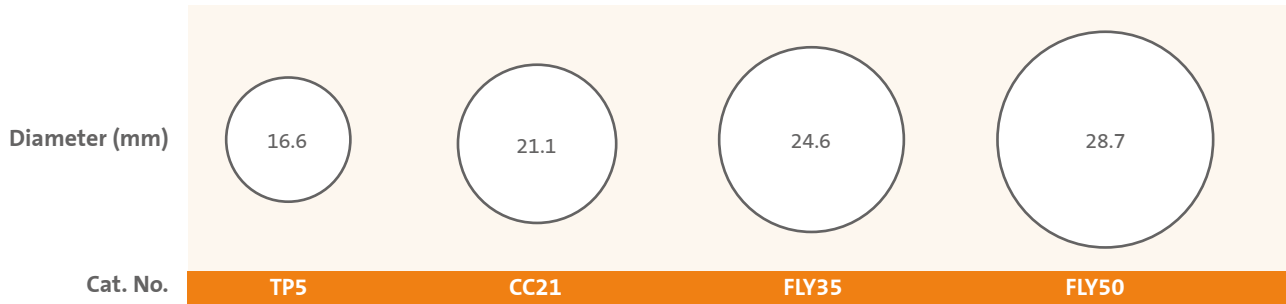
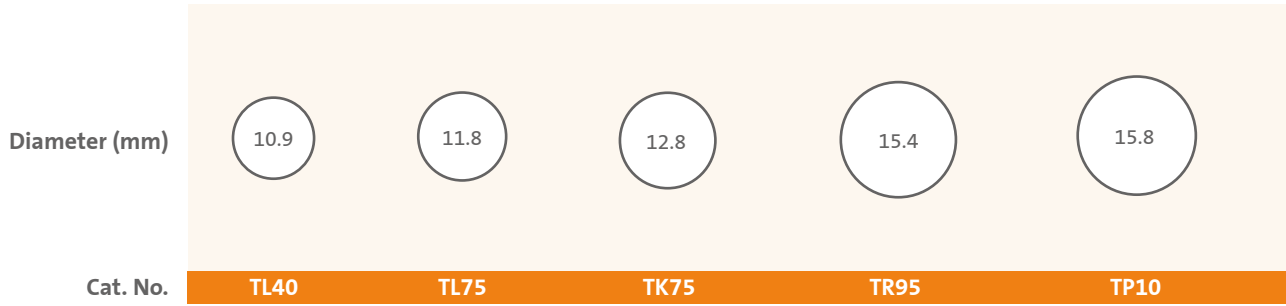



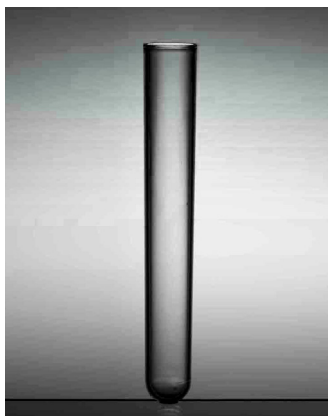



### Tubes, Round Bottom







- ▶ Centrifugation up to 3000 g with a suitable adaptor in a balanced rotor
- ▶ Polystyrene (PS) or Polypropylene (PP)
- ▶ Compatible with many popular automation systems
- ▶ For laboratory use only

#### Polystyrene

Cat. No.	Volume (mL)	Height (mm)	Diam. Ext (mm)	Cap Type	Sterile	Qty/Bag	Qty/Cs
TL40-02	2	42.5	10.9		No	1500	6000
TL40-04	2	42.5	10.9		Yes	1500	5000
TL75-01	3.5	75	11.8		No	500	3000
TL75-04	3.5	75	11.8		Yes	625	2500
TK75-001	5	74.5	12.8		No	500	2500
TK75-006	5	74.5	12.8		Yes	500	2500



#### Polypropylene

Cat. No.	Volume (mL)	Height (mm)	Diam. Ext (mm)	Cap Type	Sterile	Qty/Bag	Qty/Cs
TL75-02	3.5	75	11.8		No	500	2500
TL75-08	3.5	75	11.8		Yes	625	2500
TK75-003	5	74.5	12.8		No	500	2000
TK75-018	5	74.5	12.8		Yes	500	2000

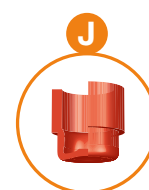

Straight plug



Winged plug



**Tubes, Round Bottom (continued)**



- ▶ Centrifugation up to 3000 g for Polystyrene (PS) with a suitable adaptor in a balanced rotor
- ▶ Centrifugation up to 6400 g for Polypropylene (PP) with a suitable adaptor in a balanced rotor
- ▶ Compatible with many popular automation systems
- ▶ For laboratory use only

**Polystyrene**

Cat. No.	Volume (mL)	Height (mm)	Diam. Ext (mm)	Cap Type	Sterile	Qty/Bag	Qty/Cs
TR95-22	10	95	15.4		No	250	1250
TR95-24	10	95	15.4		Yes	250	1000

**Polypropylene**

Cat. No.	Volume (mL)	Height (mm)	Diam. Ext (mm)	Cap Type	Sterile	Qty/Bag	Qty/Cs
TR95-23	10	95	15.4		No	250	1250
TR95-04	10	95	15.4		Yes	250	1000

**Polypropylene, Self-standing**

- ▶ Centrifugation up to 3000 g with a suitable adaptor in a balanced rotor



Cat. No.	Volume (mL)	Height (mm)	Diam. Ext (mm)	Cap Type	Sterile	Qty/Bag	Qty/Cs
TP10-03	10	96.5	15.8		No	250	1000
TP10-01	10	96.5	15.8		Yes	250	1000



Screw cap



Winged plug

### Tubes, Flat Bottom, Polypropylene



- ▶ Centrifugation up to 3000 g for Polypropylene (PP)
- ▶ Short thread screw cap
- ▶ Self-standing
- ▶ Molded graduations

Cat. No.	Volume (mL)	Height (mm)	Diam. Ext (mm)	Cap Type	Sterile	Qty/Bag	Qty/Cs
TP5-03	7	54	16.6		No	500	2000
TP5-14	7	54	16.6		Yes	400	1600



Screw cap

### Culture Tubes, Drosophila, Flat Bottom



- ▶ Polystyrene (PS)
- ▶ Self-standing
- ▶ Anti-static treatment for Drosophila breed culture

Cat. No.	Volume (mL)	Height (mm)	Diam. Ext (mm)	Sterile	Qty/Bag	Qty/Cs
FLY35-02	30	95	24.6	No	Bulk	500
FLY50-01	50	95	28.7	No	Bulk	400

### Tubes, Conical Bottom, Polystyrene

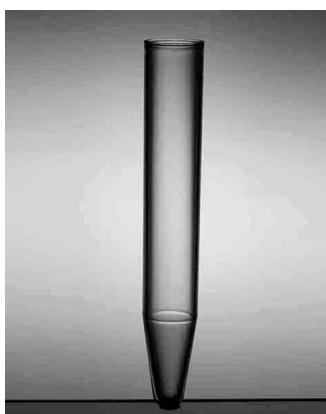

- ▶ Centrifugation up to 5400 g for Polystyrene (PS)
- ▶ Compatible with many popular automation systems

Cat. No.	Volume (mL)	Height (mm)	Diam. Ext (mm)	Cap Type	Sterile	Qty/Bag	Qty/Cs
CC21-01	10	82	21.1		No	250	1250
CC21-02	10	82	21.1		Yes	250	1000

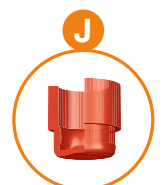

Straight plug

### Tubes, Conical Bottom, Polypropylene

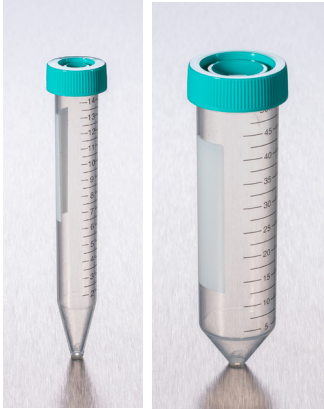

- ▶ Centrifugation up to 8000 g for Polypropylene (PP)
- ▶ Leak-resistant screw cap
- ▶ Printed graduation
- ▶ Writing area

Cat. No.	Volume (mL)	Height (mm)	Diam. Ext (mm)	Cap Type	Sterile	Qty/Bag	Qty/Cs
TC15A-03	15	118.5	17.1		No	25	500
TC15A-01	15	118.5	17.1		Yes	25	500
TC50-01	50	113.5	29.2		No	25	500
TC50-04	50	113.5	29.2		Yes	25	500

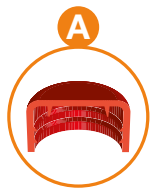

Screw cap with inner lip

### Tubes, Conical Bottom, Skirted, Polypropylene



- ▶ Centrifugation up to 3000 g
- ▶ Leak-resistant screw cap
- ▶ Self-standing
- ▶ Printed graduation
- ▶ Writing area

Cat. No.	Volume (mL)	Height (mm)	Diam. Ext (mm)	Cap Type	Sterile	Qty/Bag	Qty/Cs
TU50-012	50	114.5	29.2		No	25	500
TU50-013	50	114.5	29.2		Yes	25	500

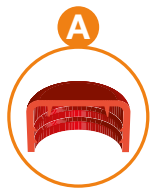

Screw cap with inner lip

### Tubes, Conical, Winged Bottom, Polystyrene

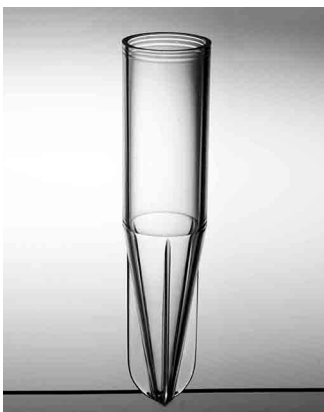

- ▶ Centrifugation up to 3000 g with a suitable adaptor in a balanced rotor
- ▶ Compatible with many popular automation systems

Cat. No.	Volume (mL)	Height (mm)	Diam. Ext (mm)	Cap Type	Sterile	Qty/Bag	Qty/Cs
CCA21-02	13	94	21.5		No	200	1800



## Closures

Overview..... 35

Features of Corning® Gosselin™ Tubes and Closures..... 35



## Overview

### Advantages of Corning® Gosselin™ Tubes and Closures

- ▶ **Manufacturing process:** All closures and tubes are produced with high-tech equipment using injection molding technology. The raw plastics used are virgin and comply with the current environmental standards. Each production lot is subject to inspection throughout the entire production process according to the standard references, which are reinforced by Corning's own specifications.
- ▶ **Tubes shapes:** Wide range of tubes: round bottom, conical bottom, flat bottom, winged bottom, can be used with the different analyzers is on the market.
- ▶ **Resistance:** Most of our tubes are designed to withstand centrifugation up to a maximum at 3000 g with a suitable adaptor in a balanced rotor.
- ▶ **Closures:** Our closures are suitable for different usage of tubes and applications. That's why we offer screw, straight, or winged caps. All closures are vertically ribbed for easier grip.
- ▶ **Packaging:** All tubes are protected with a Polyethylene outer bag placed inside the boxes beforehand to prevent any risk of particle contamination.
- ▶ **Product traceability:** Thanks to the product label on each box, we can trace each production cycle. This label includes date, time of manufacturing, and lot number.
- ▶ **Raw materials:** Compliant with the European directives in force (CE N°1935/2004). Food compatibility (94/62/EC).

### Features of Corning Gosselin Tubes and Closures

Fit	Tube Cat. No.	TL40	TL75/TC12	TK75	TK75	TR95	TR95	CC21/CCA21	TP5/TP10
	Diam. (mm)	9	10	11	11	13.5	13.5	18.5	14
Cap Type, Polyethylene	Screw 								BV160
	Straight 	B90		B110		B135		B185	
	Winged 		BA100		BA110		BA135		
Cap Color	White	B90-03	BA100-03	B110-03	BA110-23	B135-23	BA135-03		BV160-13
	Red		BA100-32		BA110-22	B135-22	BA135-02	B185-12	
	Blue		BA100-31		BA110-21	B135-21	BA135-01		
	Green		BA100-34		BA110-24		BA135-04		
	Yellow		BA100-35		BA110-25				
	Black		BA100-00		BA110-00				
	Pink		BA100-20		BA110-20				
	Grey		BA100-37						
	Orange		BA100-60		BA110-60				
	Mauve		BA100-39		BA110-29				
Natural		BA100-38	B110-08	BA110-28					
CAP Packaging	Qty/Bag	1000	3000	4000	2500	2000	1500	1000	1500
	Qty/Cs	20000	15000	16000	15000	12000	6000	6000	6000



## Sampling and Inoculation

Overview .....	37
Dippers with Removable Handle .....	38
Cutlery .....	38
Blender Bags .....	39
Clip for Bags .....	39
Pipets, Straw .....	40
Pipets, Transfer .....	40
Inoculating Loops .....	41
Stirrers .....	42
Spreaders .....	42

## Overview

### Advantages of Sampling and Inoculation Products

- Use:** A full range of disposable products from sampling to inoculation. Packaging has been designed to meet the user's expectations (individual wrapping, multiple packs). Our products are adapted in terms of packaging and product specification.
- Packaging:** All Corning® Gosselin™ products are protected by a Polyethylene outer bag placed inside the boxes beforehand to prevent any risk of particle contamination.
- Product traceability:** Thanks to the product label on each box, we can retrace each production cycle. This label includes date and time of manufacturing, lot number, and expiry date if the product has been sterilized.
- Raw materials:** Compliant with the European directives in force (CE N°1935/2004) and food compatibility (94/62/EC).

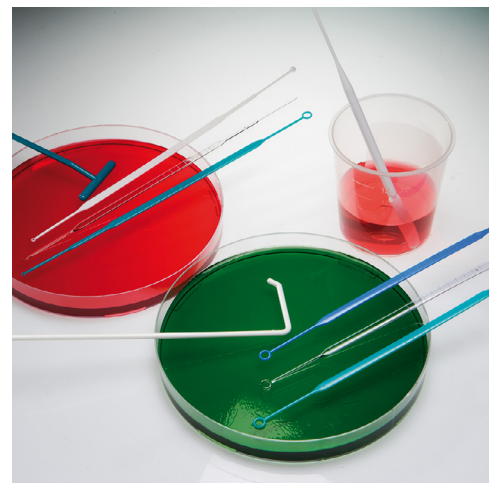

### Dippers with Removable Handle



- ▶ Blue Polypropylene (PP) containers
- ▶ Removable handle
- ▶ Single resealable bag
- ▶ Tamper-evident

Cat. No.	Volume (mL)	A (mm)	B (mm)	Diam. (mm)	Sterile	Qty/Bag	Qty/Cs
TAT30C-01*	40	70	275	30	Yes	1	250
T AFL1-01**	90	80	290	43	Yes	1	150
TAT52C-01*	125	74	275	52	Yes	1	100
TAT53C-02*	180	102	305	52	Yes	1	100

\*Screw cap.  
\*\*Hinged cap.

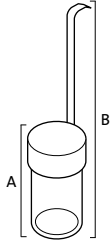

### Cutlery



- ▶ Strong Polystyrene (PS) cutlery
- ▶ Complete range
- ▶ Sampling

Cat. No.	Description	Volume (mL)	Length (mm)	Sterile	Qty/Bag	Qty/Cs
COU-02	Knife	–	175	Yes	1	1000
FOUR-01	Fork	–	155	Yes	1	1000
CUIP-01	Small spoon	2	125	Yes	1	1000
CUIG-01	Large spoon	8	150	Yes	1	1000
CFM-01	Multifunction cutlery	–	180	Yes	1	500



### Blender Bags

- ▶ Polyethylene bags
- ▶ Samples blending
- ▶ Highly resistant
- ▶ Traceability on each filter bag



#### Without Filter

Cat. No.	Volume (mL)	H x L (mm)	Thickness (µm)	Sterile	Packaging	Qty/Box	Qty/Cs
SM1-01	80	150 x 105	70	Yes	25	60 x 3	4500
SM2-02	400	300 x 180	70	Yes	25	20 x 5	2500
SM2-01	400	300 x 180	70	Yes	50	10 x 5	2500
SM3-01	3500	510 x 380	70	Yes	25	5 x 4	500



#### With Filter

Cat. No.	Volume (mL)	H x L (mm)	Thickness (µm)	Sterile	Packaging	Qty/Box	Qty/Cs
BBAG-03*	400	300 x 190	62	Yes	25	20 x 3	1500
BBAG-04*	400	300 x 190	62	Yes	50	10 x 3	1500
FBAG-03**	400	300 x 190	62	Yes	25	20 x 3	1500
FBAG-04**	400	300 x 190	62	Yes	50	10 x 3	1500

\*Side filter  
\*\*Full filter



Traceability on each filter bag.

### Clip for Bags

Cat. No.	Color	Sterile	Qty/Bag	Qty/Box	Qty/Cs
CLIP-01	Blue/White	No	50	200	1000

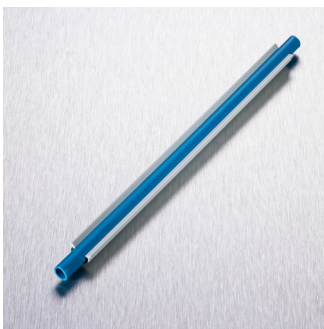

### Pipets, Straw

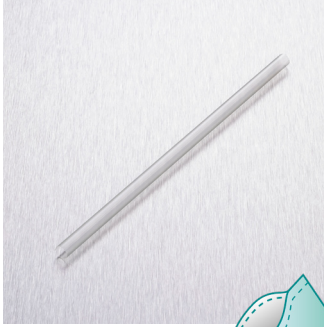

- ▶ Polypropylene (PP) straw pipets
- ▶ Packed in tamper-evident resealable plastic bag
- ▶ Liquid sampling
- ▶ Universal size

Cat. No.	Volume (mL)	Length (mm)	Sterile	Qty/Bag	Qty/Box	Qty/Cs
EPI1B-01	1	190	Yes	25	1000	12000
EPI1B-03	1	190	Yes	40	1000	12000
EPI1B-05	1	150	Yes	100	1000	12000
EPI24B-01	2.2	240	Yes	25	240	6000
EPI24B-02	2.2	240	Yes	50	120	6000
EPI5-01	5	187	Yes	10	300	3600

### Pipets, Transfer



- ▶ Polyethylene (PE) graduated pipets
- ▶ Supple
- ▶ Complete and quick removal of liquid

Cat. No.	Volume (mL)	Length (mm)	Sterile	Packaging	Qty/Box	Qty/Cs
PAS1-00	1	150	No	—	500	5000
PAS1A-01*	1	150	Yes	1	200	2000
PAS3-00	3	150	No	—	500	5000
PAS3A-01*	3	150	Yes	1	200	2000

\*Peelable bag.

### Inoculating Loops

- ▶ Highly ergonomic
- ▶ Flexible Polystyrene (PS)
- ▶ Gentle on agar
- ▶ Spherical or needle extremity (1 µL and 10 µL)
- ▶ Packed in tamper-evident resealable bags

#### Spherical Extremity

Cat. No.	Volume (µL)	Length (mm)	Color	Sterile	Qty/Bag	Qty/Box	Qty/Cs
OS1B-01	1	195	Green	Yes	20	150 x 3	9000
OS10B-02	10	195	Blue	Yes	20	150 x 3	9000

#### Needle Extremity

Cat. No.	Volume (µL)	Length (mm)	Color	Sterile	Qty/Bag	Qty/Box	Qty/Cs
OS1-01	1	192	Crystal green	Yes	20	150 x 3	9000
OS10-02	10	194	Crystal blue	Yes	20	150 x 3	9000



Spherical Extremity – 1 µL



Spherical Extremity – 10 µL

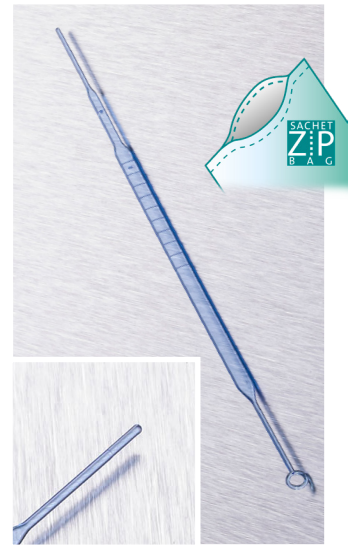

Needle Extremity – 10 µL

### Stirrers



- ▶ Polystyrene stirrers
- ▶ Packed in tamper-evident resealable bag
- ▶ Homogenization

Cat. No.	Length (mm)	Color	Sterile	Qty/Bag	Qty/Box	Qty/Cs
AGI-04	150	White	No	60	1400	7200
AGI-06	150	White	Yes	5	1000	5000

### Spreaders



- ▶ Polystyrene spreaders
- ▶ Packed in tamper-evident resealable bags

#### L-shape, Curved End

Cat. No.	Length (mm)	Color	Sterile	Qty/Bag	Qty/Box	Qty/Cs
ETAR-06	148	White	Yes	1	400	2000
ETAR-02	148	White	Yes	5	400	4000
ETAR-01	148	White	Yes	25	1000	5000
ETAR-05	148	White	Yes	50	1200	6000

#### T-shape, More Precise



Cat. No.	Length (mm)	Color	Sterile	Qty/Bag	Qty/Box	Qty/Cs
ETAT-03	150	Green	Yes	1	300	1500
ETAT-01	150	Green	Yes	5	500	2500
ETAT-04	150	Green	Yes	25	700	3500



## Transportation and Disposal

Overview .....	44
Waste and Sharp Containers.....	45
Pipet Container .....	45
Bags .....	46
Resealable Bags, Double-pocket .....	46
Bag, Self-adhesive .....	46
Bags, Metal Closure .....	47
Bags, Autoclave.....	48
Slide Mailer.....	48
Buckets .....	49
Tub .....	49

## Overview

### Advantages of Transportation and Disposal Range of Products

- ▶ **Use:** These products meet the usual requirements for the different applications (clinical, microbiology, industrial). Our transportation products comply with industry standards where applicable.
- ▶ **Packaging:** All products are protected by a Polyethylene outer bag placed inside the box beforehand to avoid any risk of particle contamination.
- ▶ **Product traceability:** Thanks to the product label on each box, we can trace each production cycle. This label includes date, time of manufacturing, and lot number.
- ▶ **Raw materials:** Compliant with the European directives in force (CE N°1935/2004) and food compatibility (94/62/EC).



### Waste and Sharp Containers



- ▶ Medical and portable use
- ▶ Polypropylene body
- ▶ Autoclavable
- ▶ Definitive tamper-resistant closure
- ▶ Nonsterile

**BS 7320  
NF X 30-511**

Cat. No.	Volume (mL) Useful Capacity	Height (mm)	Length (mm)	Width (mm)	Qty/Cs
COX600A-02	510	125	117	73	70
COX800A-02	690	165	116	74	65
COX1100A-02	930	225	115	74	60
COX1800A-02	1590	140	192	126	45
COX4500A-02	3450	278	190	129	42
COX7000A-02	4870	390	190	133	25

### Pipet Container



- ▶ Medical and portable use
- ▶ Polypropylene body
- ▶ Autoclavable
- ▶ Definitive tamper-resistant closure
- ▶ Nonsterile

Cat. No.	Volume (mL)	Height (mm)	Length (mm)	Qty/Cs
PIPB-01	5000	166	343 x 155	16

## Bags



### Resealable Bags, Double-pocket

- ▶ Polyethylene resealable bags
- ▶ Quick closure system
- ▶ Double pocket
- ▶ Ideal for transport
- ▶ Nonsterile

Cat. No.	Length x Height (mm)	Color	Qty/Box	Qty/Cs
SP2-18	125 x 170	Natural	1000	4000
SP2-01	125 x 170	Blue	1000	4000
SP2-02	125 x 170	Red	1000	4000
SP2-05	125 x 170	Yellow	1000	4000
SP4-38	150 x 200	Natural	1000	4000
SP5-08	160 x 220	Natural	1000	2000
SP8-08	200 x 300	Natural	1000	1000
SP8-01	200 x 300	Blue	1000	1000

### Bag, Self-adhesive

- ▶ Polyethylene (LDPE) self-adhesive bag
- ▶ With writing area
- ▶ Biohazard labeling
- ▶ Double pocket
- ▶ Nonsterile



Cat. No.	With Absorbent	Length x Height (mm)	Thickness (µm)	Qty/Cs
SFAB1727-08	No	170 x 270	40	2000



Biohazard symbol on printed bags



**Bags, Metal Closure**

- ▶ Polyethylene bags
- ▶ Quick closure system
- ▶ Single pocket
- ▶ Ideal for sampling and transport
- ▶ Nonsterile

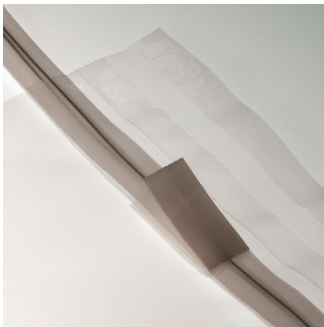
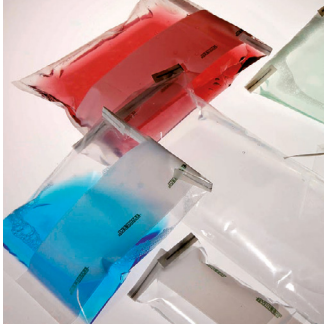

Metal closures

Cat. No.	Volume (ml)	Length x Height (mm)	Thickness (µm)	Qty/Box	Qty/Cs
SBAPE7518-01*	150	76 x 178	63	500	1000
SBA9518-01	210	89 x 178	76	500	1000
SBAPE1123-01*	450	114 x 229	63	500	1000
SBA1123-01	450	114 x 229	63	500	1000
SBAPE1523-01*	650	140 x 229	76	500	1000
SBA1423-01	650	140 x 229	76	500	1000
SBA1538-01	1500	140 x 382	76	500	1000
SBAPE1930-01*	1650	178 x 305	76	250	1000

\*With writing area.

### Bags, Autoclave



- ▶ Polypropylene bags
- ▶ Every bag is 40 µm thick
- ▶ Thermal resistance of 134°C
- ▶ Wide range of volumes available (3000 mL to 33000 mL)
- ▶ Nonsterile

#### Transparent

Cat. No.	Volume (mL)	Height (mm)	Length (mm)	Thermal Resistance	Qty/Cs
SA03-01	3000	400	255	134°C	500
SA09-01	9000	500	300	134°C	500
SA14-01	14000	600	400	134°C	500
SA21-01	21000	780	400	134°C	500
SA33-01	33000	780	600	134°C	500



#### Transparent, Biohazard Symbol Printed

Cat. No.	Volume (mL)	Height (mm)	Length (mm)	Thermal Resistance	Qty/Cs
SA03-10	3000	400	255	134°C	500
SA09-10	9000	500	300	134°C	500
SA14-10	14000	600	400	134°C	500
SA21-10	21000	780	400	134°C	500
SA33-10	33000	780	600	134°C	500



Biohazard symbol on printed bags

#### Recommendation

Bags must not be tightly sealed to withstand the temperature recommended for 20 minutes in autoclave.

### Slide Mailer



- ▶ Polypropylene slide mailer
- ▶ For two slides
- ▶ Snap closure
- ▶ Slide protection
- ▶ Transport of microscope slides
- ▶ Nonsterile

Cat. No.	Width (mm)	Length (mm)	Height (mm)	Qty/Cs
PLP-01	72	85	5	700

**Buckets**



- ▶ White Polypropylene bucket and closure
- ▶ Tamper-evident seal
- ▶ Carry handle
- ▶ Nonsterile

Cat. No.	Volume (mL)	Height (mm)	Diam. (mm) Inside Top	Diam. (mm) Outside-bottom	Closure	Qty/Cs
JT30-01	3000	139	184	170		80
JT38-01	3800	177	184	166		75
JT57-05	5700	195	210	191		45
JT10-01	10700	264	251	226		20
JT16-01	16000	275	311	286		10



**Tub**



- ▶ White Polypropylene tub
- ▶ Snap cap
- ▶ Opaque
- ▶ Nonsterile

Cat. No.	Volume (mL)	Height (mm)	Diam. (mm) Inside Top	Diam. (mm) Outside-bottom	Closure	Qty/Cs
BAC25-03	2500	173	148	145		144



## Technical Appendix

Features of Corning® Gosselin™ Plasticware .....	51
Chemical Compatibility of Corning Gosselin Plasticware ....	52
Traceability .....	53
Ionization Certificate .....	53
Product Label .....	53

# Features of Corning® Gosselin™ Plasticware

Reagents	HDPE		PS		PP		LDPE		PET	
	68°F 20°C	122°F 50°C	68°F 20°C	122°F 50°C	68°F 20°C	122°F 50°C	68°F 20°C	122°F 50°C	68°F 20°C	122°F 50°C
Perchloric acid	G	N	G	F	G	N	G	N	F	F
Phosphoric acid 85%	R	R	R	G	R	G	R	R	F	F
Sulfuric acid 20%	R	R	R	G	R	G	R	R	N	N
Trichloroacetic acid	G	F	F	N	R	G	G	F	F	N/A
Butyl alcohol	R	R	G	G	R	R	R	R	G	G
Ethyl alcohol	R	R	F	N	R	G	R	G	G	G
Methyl alcohol	R	R	F	N	R	R	R	R	G	F
Acetaldehyde	G	F	N	N	G	N	G	N	F	N
Aniline	R	G	F	F	G	F	R	G	G	F
Benzene	G	G	N	N	G	F	G	N	F	N
Potassium dichromate	R	R	R	G	R	G	R	G	F	N/A
Bromine	F	N	N	N	N	N	N	N	N	N
Bromoform	N	N	N	N	N	N	N	N	N	N
Butadiene	F	N	N	N	N	N	N	N	N	N
Cellosolve	R	R	F	F	R	G	R	G	N/A	N/A
Chlorine (moist)	G	F	N	N	G	N	G	N	N	N
Chlorine in air	R	F	F	N	G	N	G	N	N	N
Chloroform	G	F	N	N	G	F	F	N	N	N
Amyl chloride	F	N	N	N	N	N	N	N	N	N
Ethylene chloride	G	F	N	N	F	N	G	N	N	N
Ethyl chloride	F	F	N	N	F	N	F	N	N	N
Methylene chloride	G	F	N	N	F	N	F	N	N	N
Thionyl chloride	N	N	N	N	N	N	N	N	N	N
Cresol	F	N	N	N	G	F	N	N	N	N
Cyclohexane	R	G	N	N	G	F	G	F	R	N/A
P-dichlorobenzene	G	F	N	N	G	F	F	N	F	F
Dioxane	G	G	N	N	G	F	G	F	R	R
Hydrogen peroxide	R	R	R	G	R	G	R	G	R	R
Gasoline	G	G	N	N	G	F	F	N	R	G
Petroleum ether	F	N	F	F	G	F	F	F	R	G
Ethyl ether	N	N	N	N	N	N	F	N	R	G
Formaldehyde	R	R	G	G	R	G	R	G	R	R
Hexane	R	R	N	N	R	R	R	R	R	R
Mineral oil	R	R	R	R	R	R	G	N	R	R
Calcium hypochlorite	R	R	G	F	R	R	R	R	R	R
Sodium hypochlorite	R	R	R	R	R	R	R	R	G	N/A
Kerosene	G	G	N	N	G	F	F	N	R	R
Methyl isobutyl ketone	R	G	N	N	G	F	G	F	G	F
Silver nitrate	R	G	G	F	R	G	G	F	R	R
Ethylene oxide	F	F	N	N	F	F	G	F	N/A	N/A
Potassium permanganate	R	R	G	G	R	G	R	G	R	R
Phenol	G	F	N	N	G	N	G	N	N	N
Propane	F	N	N	N	N	N	N	N	F	N
Turpentine	G	G	N	N	G	F	F	N	G	G
Carbon tetrachloride	G	F	N	N	G	F	F	N	R	R
Tetrahydrofuran	G	F	N	N	G	F	F	N	N	N
Trichloroethane	F	N	N	N	N	N	N	N	N	N
Trichloroethylene	F	N	R	R	N	N	N	N	F	N
Toluene	G	G	N	N	G	F	F	N	R	N
Urea	R	R	G	G	R	R	R	R	R	R
Xylene	G	F	N	N	F	N	G	N	N	N

**G** = Good resistance for continuous use not exceeding 30 days  
**F** = Fair resistance for continuous use not exceeding 7 days  
**N** = Not recommended for continual use  
**R** = Excellent resistance  
**N/A** = Not applicable

HDPE = High-density polyethylene  
 LDPE = Low-density polyethylene  
 PET = Polyethylene terephthalate  
 PP = Polypropylene  
 PS = Polystyrene

## Chemical Compatibility of Corning® Gosselin™ Plasticware

Reagents (20°C)	HDPE	PS	PP	LDPE	PET
Weak or diluted acids	R	R	R	R	R
Strong or concentrated acids	R	F	R	R	N
Aliphatic alcohols	R	R	R	R	F
Aldehydes	G	N	G	G	G
Bases	R	R	R	R	N
Esters	G	N	G	G	G
Aliphatic hydrocarbons	G	N	G	F	G
Aromatic hydrocarbons	G	N	F	F	N
Halogenated hydrocarbons	F	N	F	N	N
Cetane	G	N	G	G	F
Oxidizing agents	F	N	F	F	F

**G** = Good resistance for continuous use not exceeding 30 days

**F** = Fair resistance for continuous use not exceeding 7 days

**N** = Not recommended for continual use

**R** = Excellent resistance

**N/A** = Not applicable

HDPE = High-density polyethylene

LDPE = Low-density polyethylene

PET = Polyethylene terephthalate

PP = Polypropylene

PS = Polystyrene

The data in this product selection guide are based on information and documentation provided by our raw material suppliers and on our own many years of technical experience. Customers should test our products to ensure that they are suitable for their own specific requirements. The information provided is for guidance only and we cannot accept further responsibility.

## Traceability

All Corning® Gosselin™ products come with convenient traceability features such as labels with lot number and expiration date. These labels easily peel-off and can be placed in your laboratory notebook.

## Ionization Certificate

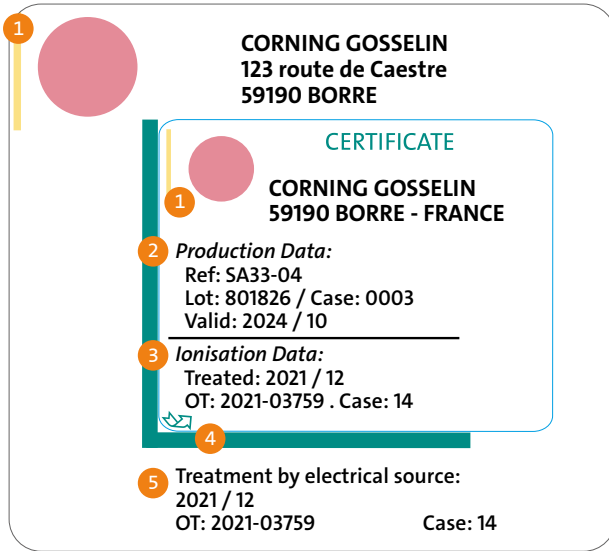

- 1 Sterilization indicator: becomes red after sterilization
- 2 Product information: reference, lot number
- 3 Sterilization information: date, carton number
- 4 Detachable certificate (for your records)
- 5 Details and information remain on the outer carton

## Product Label

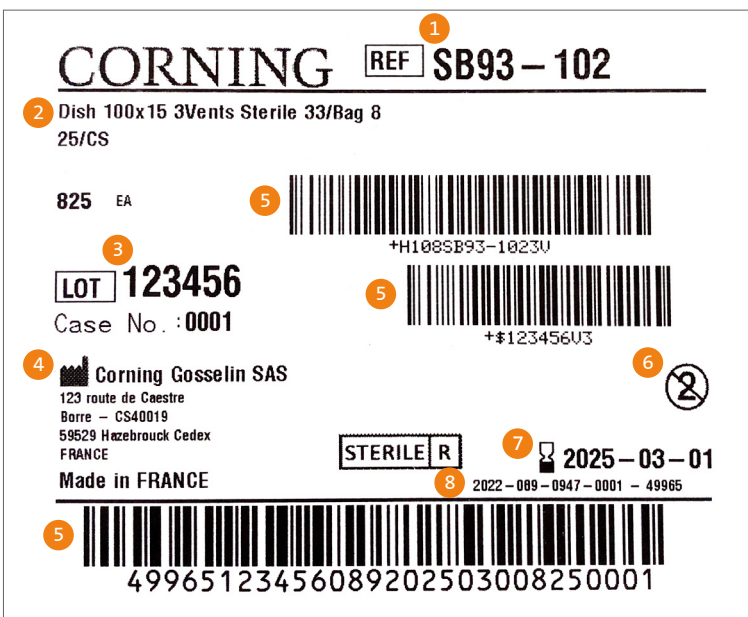

- 1 Catalog number
- 2 Product description, quantity per case
- 3 Lot number
- 4 Manufacturing plant
- 5 Bar codes
- 6 Single use symbol
- 7 Expiration date
- 8 Year, day, time of production, and case number

## Catalog Number Index

Cat. No.	Page No.	Cat. No.	Page No.	Cat. No.	Page No.	Cat. No.	Page No.
AGI-04	42	CC21-01	32	FLY35-02	32	LC1000-02	13
AGI-06	42	CC21-02	32	FLY50-01	32	LC1000-04	13
B90-03	35	CCA21-02	33	FOUR-01	38	LC1000-06	13
B110-03	35	CFM-01	38	FV250-02	16	LC1000-07	13
B110-08	35	CLIP-01	39	FV250-05	16	LC1000-13	13
B135-21	35	COUT-02	38	FV250-09	16	LC2000-01	13
B135-22	35	COX600A-02	45	FV250-15	16	LC2000-03	13
B135-23	35	COX800A-02	45	FV500-04	16	LC2000-05	13
B185-12	35	COX1100A-02	45	FV500-05	16	LC2000-07	13
BA100-00	35	COX1800A-02	45	FV500-09	16	LC2000-08	13
BA100-03	35	COX4500A-02	45	FV500-14	16	LC2000-17	13
BA100-20	35	COX7000A-02	45	HFC500-01	20	LR50A-01	15
BA100-31	35	CUIG-01	38	HFC510-01	20	LR50A-02	15
BA100-32	35	CUIP-01	38	HFC510-02	20	LR50A-05	15
BA100-34	35	EPI1B-01	40	HFC510-03	20	LR50A-12	15
BA100-35	35	EPI1B-03	40	HFC510-04	20	LR50A-18	15
BA100-37	35	EPI1B-05	40	HFC520-01	20	LR100-01	15
BA100-38	35	EPI5-01	40	HFC520-02	20	LR100-03	15
BA100-39	35	EPI24B-01	40	HFC520-06	20	LR100-04	15
BA100-60	35	EPI24B-02	40	HFC520-07	20	LR100-05	15
BA110-00	35	ETAR-01	42	HFC1000-50	20	LR100-12	15
BA110-20	35	ETAR-02	42	HFC1000-51	20	LR100-13	15
BA110-21	35	ETAR-05	42	HFC1000-52	20	LR150A-01	15
BA110-22	35	ETAR-06	42	HFC1000-53	20	LR150A-02	15
BA110-23	35	ETAT-01	42	HFV250-01	19	LR150A-03	15
BA110-24	35	ETAT-03	42	HFV250-02	19	LR150A-04	15
BA110-25	35	ETAT-04	42	HLC250-01	19	LR150A-07	15
BA110-28	35	F2000-02	13	HLC250-02	19	LR150A-14	15
BA110-29	35	F2000-12	13	HLC500-11	19	LR250-01	15
BA110-60	35	FBAG-03	39	HLC1000-11	19	LR250-02	15
BA135-01	35	FBAG-04	39	HLC1000-12	19	LR250-04	15
BA135-02	35	FC500-03	14	HLC2000-11	19	LR250-06	15
BA135-03	35	FC500-12	20	HP250B-50	18	LR250-07	15
BA135-04	35	FC510-02	14	HP250B-51	18	LR250-09	15
BAC25-03	49	FC510-07	20	HP250B-53	18	LR500-01	15
BB64-01	6	FC520-02	14	HP500B-50	18	LR500-02	15
BB64-02	6	FC520-08	14	HP500B-51	18	LR500-03	15
BBAG-03	39	FC520-12	20	HP1000B-53	18	LR500-04	15
BBAG-04	39	FC1000-18	20	JT10-01	49	LR500-05	15
BH90B-102	7	FC1000-50	14	JT16-01	49	LR500-06	15
BH93B-102	7	FC1000-52	14	JT30-01	49	LR1000-01	16
BI93D-101	8	FCP100-01	14	JT38-01	49	LR1000-02	16
BI93D-102	8	FCP100-02	14	JT57-05	49	LR1000-03	16
BP50-01	6	FCP250-02	14	LC150A-03	12	LR1000-04	16
BP50-02	6	FCP250-03	14	LC150A-04	12	LR1000-05	16
BP53-03	6	FCP500-02	14	LC150A-05	12	LR1000-08	16
BP53-06	6	FCP500-04	14	LC150A-07	12	LR2000-01	16
BP63-08	6	FCP1000-03	14	LC150A-09	12	LR2000-02	16
BP63-10	6	FCP1000-04	14	LC250-01	12	LR2000-03	16
BP63-11	6	FCP2000-03	14	LC250-02	12	OS1-01	41
BP90B-101	7	FCP2000-04	14	LC250-03	12	OS1B-01	41
BP90B-102	7	FL35-02	23	LC250-04	12	OS10-02	41
BP93B-101	7	FL52-01	23	LC250-06	12	OS10B-02	41
BP93B-102	7	FL60-01	23	LC250-10	12	P125B-05	11
BP124-04	8	FL60-04	23	LC250-20	12	P125B-08	11
BP124-05	8	FL60-05	23	LC500-01	13	P125B-50	11
BP140-01	7	FL100-01	23	LC500-02	13	P250B-01	11
BP140-02	7	FL100-04	23	LC500-03	13	P250B-50	11
BP143-06	7	FL100-05	23	LC500-04	13	P250B-51	18
BP143-07	7	FL300-01	23	LC500-07	13	P500B-09	11
BT93-02	8	FL300-02	23	LC500-11	13	P500B-50	11
BV160-13	35	FL300-04	23	LC1000-01	13	P500B-51	18



Cat. No.	Page No.	Cat. No.	Page No.	Cat. No.	Page No.	Cat. No.	Page No.
P1000B-06	11	PV500-01	27	TAT52C-01	38	TP35C-042	24
P1000B-50	11	SA03-01	48	TAT53C-02	38	TP35C-052	24
P1000B-51	18	SA03-10	48	TC15A-01	33	TP35C-062	24
P1000B-52	18	SA09-01	48	TC15A-03	33	TP52C-001	25
PAS1-00	40	SA09-10	48	TC50-01	33	TP52C-002	25
PAS1A-01	40	SA14-01	48	TC50-04	33	TP52C-003	25
PAS3-00	40	SA14-10	48	TK75-001	30	TP52C-004	25
PAS3A-01	40	SA21-01	48	TK75-003	30	TP52C-011	25
PC200A-01	26	SA21-10	48	TK75-006	30	TP52C-012	25
PC200A-02	26	SA33-01	48	TK75-018	30	TP52C-013	25
PC200A-03	26	SA33-10	48	TL40-02	30	TP52C-014	25
PC200A-04	26	SB90-101	7	TL40-04	30	TP52C-021	25
PC200A-05	26	SB93-101	7	TL75-01	30	TP52C-022	25
PC200A-07	26	SB93-102	7	TL75-02	30	TP52C-023	25
PC200A-11	26	SBA1123-01	47	TL75-04	30	TP52C-024	25
PC400-01	26	SBA1423-01	47	TL75-08	30	TP52C-025	25
PC400-02	26	SBA1538-01	47	TP5-03	32	TP52C-032	25
PC400-03	26	SBA9518-01	47	TP5-14	32	TP53C-001	25
PC400-05	26	SBAPE1123-01	47	TP10-01	31	TP53C-002	25
PC400-06	26	SBAPE1523-01	47	TP10-03	31	TP53C-003	25
PC400-09	26	SBAPE1930-01	47	TP30C-001	24	TP53C-004	25
PC1000-02	26	SBAPE7518-01	47	TP30C-002	24	TP53C-011	25
PC1000-03	26	SFAB1727-08	46	TP30C-003	24	TP53C-012	25
PC1000-04	26	SH90-101	7	TP30C-004	24	TP53C-013	25
PC1000-05	26	SH93-101	7	TP30C-011	24	TP53C-014	25
PC1000-09	26	SM1-01	39	TP30C-012	24	TP53C-021	25
PC1000-11	26	SM2-01	39	TP30C-013	24	TP53C-023	25
PC1000-13	26	SM2-02	39	TP30C-014	24	TP53C-032	25
PIPB-01	45	SM3-01	39	TP30C-021	24	TP53C-042	25
PLP-01	48	SP2-01	46	TP35C-001	24	TP53C-052	25
PR500-02	27	SP2-02	46	TP35C-002	24	TP200-02	25
PR800-01	27	SP2-05	46	TP35C-004	24	TP200-14	25
PR1000-01	27	SP2-18	46	TP35C-011	24	TR95-04	31
PR1000-02	27	SP4-38	46	TP35C-012	24	TR95-22	31
PR1050-01	27	SP5-08	46	TP35C-013	24	TR95-23	31
PV30-01	27	SP8-01	46	TP35C-014	24	TR95-24	31
PV75-01	27	SP8-08	46	TP35C-021	24	TU50-012	33
PV100-24	27	TAF11-01	38	TP35C-025	24	TU50-013	33
PV125-01	27	TAT30C-01	38	TP35C-032	24		



BIOHAZARD

should be left open to allow penetration  
être maintenu ouvert pour laisser pénétrer

base of bag should be supported  
le fond du sac doit être soutenu

For up-to-date information on the  
Corning® Gosselin™ brand comprehensive  
range of products and services, visit  
[www.corning.com/microbiology](http://www.corning.com/microbiology).

**Warranty/Disclaimer:** Unless otherwise specified, all products are for research use or general laboratory use only.\* Not intended for use in diagnostic or therapeutic procedures. Not for use in humans. These products are not intended to mitigate the presence of microorganisms on surfaces or in the environment, where such organisms can be deleterious to humans or the environment. Corning Life Sciences makes no claims regarding the performance of these products for clinical or diagnostic applications. \*For a listing of US medical devices, regulatory classifications or specific information on claims, visit [www.corning.com/resources](http://www.corning.com/resources).

*Corning's products are not specifically designed and tested for diagnostic testing. Many Corning products, though not specific for diagnostic testing, can be used in the workflow and preparation of the test at the customers discretion. Customers may use these products to support their claims. We cannot make any claims or statements that our products are approved for diagnostic testing either directly or indirectly. The customer is responsible for any testing, validation, and/or regulatory submissions that may be required to support the safety and efficacy of their intended application.*

# CORNING

Corning Incorporated  
Life Sciences

[www.corning.com/lifesciences](http://www.corning.com/lifesciences)

## NORTH AMERICA

t 800.492.1110

t 978.442.2200

## ASIA/PACIFIC

Australia/New Zealand

t 61 427286832

Chinese Mainland

t 86 21 3338 4338

India

t 91 124 4604000

Japan

t 81 3-3586 1996

Korea

t 82 2-796-9500

Singapore

t 65 6572-9740

Taiwan

t 886 2-2716-0338

## EUROPE

CSEurope@corning.com

France

t 0800 916 882

Germany

t 0800 101 1153

The Netherlands

t 020 655 79 28

United Kingdom

t 0800 376 8660

## All Other European Countries

t +31 (0) 206 59 60 51

## LATIN AMERICA

grupolA@corning.com

Brazil

t 55 (11) 3089-7400

Mexico

t (52-81) 8158-8400